

OWNER'S MANUAL

ATTENTION INSTALLER

This manual **MUST** accompany the owner of this Stay-In-Play DUO



DEMCO

**IMPORTANT
WARRANTY REGISTRATION HERE:**



SERIAL NUMBER

ATTENTION INSTALLER!!



TO BE REVIEWED BY INSTALLER OR END USER

The Stay-IN-Play Duo braking system's activation is progressive in nature. Careful attention must be given to the adjustment of the system.

Under no circumstances should the unit operate while stationary or with the turn signals.

This will result in potential damage to the towed vehicle and DUO braking system. Refer to step 12 in the installation instructions for proper adjustment procedure.

CABLE BREAKAGE

Cable breakage can only occur if there is an improper angle or if the cable is overtightened in the anchor. **Review this step carefully** after the cylinder is mounted to ensure proper installation. Also make sure there is a minimum of 3 ½" - 4" between the end of the cylinder and the anchor when brake pedal is released.

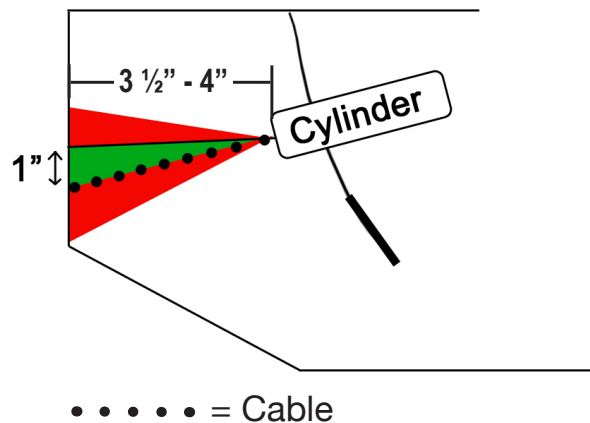

Thank you for purchasing Stay-IN-Play Duo: the most advanced inertia-based braking system. When installed correctly, this system will provide years of maintenance-free service. These installation instructions are designed to guide you through the installation of your new braking system. Although the installation is not difficult, **it is imperative that these instructions be read in their entirety before any part of the installation is attempted.** This will allow for a proper understanding of the system as a whole, and will consequently result in a much neater, professional installation. These instructions are a compilation of feedback from technicians, installers, and individual customers; and we believe them to be complete and thorough. However, if, for any reason, clarification is needed feel free to contact us at 800-543-3626.

WARRANTY POLICY, OPERATOR MANUALS, PARTS MANUALS & REGISTRATION

Go online to www.demco-products.com to review Demco warranty policies, operator manuals and register your Demco product.

TABLE OF CONTENTS

Product Definition..... Page 3
Parts BreakdownPage 4 - 6
Things to Know Page 7
Towed-Vehicle Installation Page 8- 19
Testing the Installation Page 18
Troubleshooting.....Page 20
Wiring Diagram..... Page 21
Plumbing Diagram..... Page 22
Warranty Information..... Page 23

SERIAL NUMBER: _____

INVENTORY OF PARTS

6255 SMALL PARTS KIT

ITEM	PART #	QTY	DESCRIPTION
1	01883	5	CONNECTOR TAP IN
2	02772	1	NUT, .25NC LOCK NYLON INSERT
3	04055	1	.25-20NC X 1 GR5 HEX
4	05744	2	TERMINAL RING .25 18-20GA BLUE
5	07378	9	CONNECTOR BUTT
6	16016	1	FUSE 20 AMP ATO
7	16021	1	FUSE HOLDER
8	16025	1	TERMINAL 3-WAY CRIMP
9	16027	2	.375 X .50 BARBED ADAPTER
10	16030	1	BREAKAWAY DEAD PLUG
11	16032	1	BREAKAWAY SWITCH
12	16110	10	CABLE ZIP TIE 8"
13	16122	1	WASHER .25 FENDER
14	16126	1	CHECK VALVE .375 BARBED
15	16128	1	FTG TEE .375 X 3 BARBED
16	6211	1	BREAKAWAY CABLE (SEE BELOW)
17	B6HN	2	CLAMP GEAR NARROW SS .375 HOSE
18	16166	5	PRIMARY WHITE WIRE #16 (NOT SHOWN)
19	16022	2	10 AMP DIODE

Please order replacement parts by PART NO. and DESCRIPTION

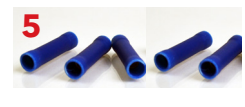

6211 BREAKAWAY CABLE KIT

ITEM	PART #	QTY	DESCRIPTION
1	16050	2	CARABINER HOOK 6 mm
2	16138	1	CABLE BREAKAWAY COILED

Please order replacement parts by PART NO. and DESCRIPTION

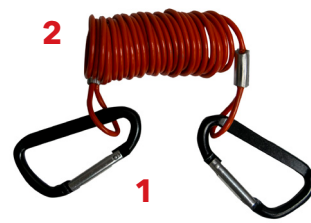

6258 G FORCE CONTROLLER KIT



6242 STAY-IN-PLAY DUO OPERATING UNIT



6213 COACH NOTIFICATION KIT (#9599018 NOT INCLUDED)

ITEM	PART #	QTY	DESCRIPTION
1	05744	1	TERMINAL RING .25, 18-20 GA. BLUE
2	07378	3	CONNECTOR BUTT
3	16024	1	TERMINAL T-TAP CONNECTOR
4	16025	1	TERMINAL 3-WAY CRIMP
5	16028	1	TERMINAL MALE SPADE .25
6	16144	1	LED LIGHT
7	16146	5	WIRE BLACK (SOLD PER FOOT, 5' REQUIRED)
8	16147	5	WIRE RED (SOLD PER FOOT, 5' REQUIRED)

Please order replacement parts by **PART NO.** and **DESCRIPTION**



6215 STAY-IN-PLAY DUO AIR CYLINDER KIT

ITEM	PART #	QTY	DESCRIPTION
1	6215	1	AIR CYLINDER KIT
2	16127	1	CABLE ANCHOR
3	16151	3	SCREW 14 X 1.00 HEX HD WASHER DRILL TAP
4	16707-95	1	REPLACEMENT PLATE F/ CABLE ANCHOR
5	16065	4	SCREW 10/32 X 2-1/2" (For use with wider brake pedal arm)

Please order replacement parts by **PART NO.** and **DESCRIPTION**



16114



**10' - 1/4" DOT Air Line
(sold per foot)**

380RB



7' Length of 3/8" Vacuum Hose (sold per foot)

6257 OPTIONAL VACUUM TEE
AVAILABLE FROM DEMCO 1-800-543-3626



6257 INSTALLED



6492 AIR PRESSURE REGULATOR

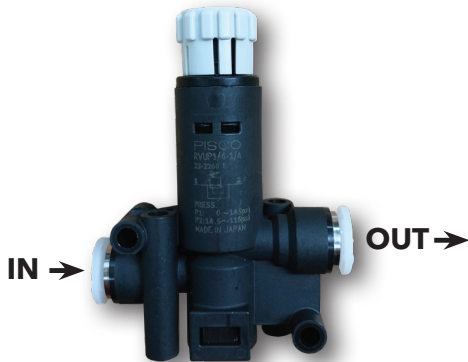

**OPTIONAL 6492 AIR PRESSURE REGULA-
TOR FOR THE FORD MAVERICK INSTALLATION.**
AVAILABLE FROM DEMCO 1-800-543-3626

The air pressure regulator is preset from the factory. It WILL BE necessary to fine tune the amount of air being regulated depending on the size of coach used. Cut the air line 10-12" away from the main operating unit. With the writing on the valve facing you, the inlet of the valve will be on your left. To raise the air pressure, you will lift the knob and turn it clockwise and then push the knob down to lock it in place. Counterclockwise will lower the pressure. Fine tune the system so that it doesn't drag the tires of the towed vehicle. Be sure there is enough pressure to stop the vehicle under a break-away situation.

Keep the notification light in your line of sight. **If it illuminates when not needed, or fails to extinguish when appropriate, stop immediately.** It indicates that the towed vehicle's brakes are engaged, which could cause serious damage! Note: As an option, a wire may be run to the front of the coach for a monitor light. The wire may even be connected to an extra terminal in the tow wiring plug to avoid an extra connection between the vehicles. Any 12v light can be used.

Be sure to have your towed-vehicle's brakes inspected for wear before towing. In most cases towed vehicles do not accrue mileage on the odometer while in tow, resulting in the brakes needing to be serviced before the odometer would dictate. For most vehicles it is recommended to have the brakes inspected/replaced every 20,000-30,000 miles. **You must combine towing and driving mileage when determining the interval.**

Stay-IN-Play Duo is designed to provide progressive braking effort based on the brake lights of the coach AND inertia (stopping G-force). **Stay-IN-Play Duo should not activate while the coach is not moving.** If you find that Stay-IN-Play Duo does activate while stationary, adjust the G-Force Controller II accordingly.

The Demco Stay-IN-Play Duo's brake actuator uses an internal spring to retract the brake pedal, thereby assuring there is no drag on the towed vehicle's brakes. Before towing, check the operation of the air cylinder with the breakaway and observe the operation of the brake pedal. Verify total release of the towed vehicle's brakes before towing.

The Stay-IN-Play DUO is designed to be used behind a hydraulic brake coach. It is NOT recommended to be used behind an air brake coach. Demco recommends using the Air Force One behind an air brake coach. The wiring installation utilizes the brake lights of the RV to activate the Demco system in combination with "G-Force." If your hydraulic brake coach is equipped with an exhaust brake that illuminates the brake lights of the coach, extra attention must be given to the activation light. On steep grades all G-Force sensors will sense inertia faster and more quickly due to the angle of the grade. You may need to adjust it slightly closer to the "less sensitive" (upper) position. This has very little effect in the activation of the Demco Stay-IN-Play Duo on level terrain because of the difference in G-Force with two wheels braking (as in an exhaust brake) and with four (or more) wheels braking when the service brakes are applied. The G-Force Sensor will likely not need to be re-adjusted.

Step 1: Check the Towed Vehicle's Wiring

Note: Improper tow wiring will result in problems with the Stay-IN-Play Duo System.

1. Place the car in tow position behind the motor home.
2. Connect the tow-wiring umbilical cord to the towed vehicle. **Do NOT connect the tow bar.**
3. Test the running lights, turn signal lights, and the brake lights on the towed vehicle. (Now is the time to repair any inoperable signals.) If the lights appear dim the cause is likely a poor ground in the coach or towed vehicle.
4. While someone is holding the brake pedal down in the motor home, use a test light to determine the color of the brake-light wire (there may be one [normally red] or two [normally yellow and green] brake light wires) in the wiring harness from the coach under the hood of the towed vehicle.

Step 2: Mount the Operating Unit

1. Select a suitable location for the operating unit in the engine compartment. It must be away from any extreme heat source and the connections must be easily accessible. The unit can often be installed behind the grill provided it doesn't restrict air flow to the radiator. Moisture will not harm the unit, but it should not be in the direct path of rainwater or road spray.
2. Secure the box with either screws or wire ties through the mounting flanges on the box.



SCAN CODE HOW TO INSTALL STAY N PLAY DUO

Step 3: Mount the G-Force Controller II

1. Find an appropriate location to mount the G-Force Controller within the passenger compartment of the vehicle. Keep in mind, the G-Force Controller is not weather proof, and it MUST be mounted in a specific orientation and level. **The Demco logo must face towards the passenger side of the vehicle**, and the toggle switch must face toward the rear of the vehicle. The tow-kick panel and the B-pillar (beside the driver's seat) are acceptable locations provided there is ample room.
2. Use the provided screws to secure the box in this location making sure that the area behind is clear.



Step 4: Install the Monitor Light

Note: If the vehicle has a “dead” brake-light switch when in the towed position (the brake lights are inoperable with the key in the tow position) or the vehicle’s battery is disconnected while in tow, the Red wire below should be attached to the blue wire that goes between the breakaway switch and the operating unit. Most 2009+ GM’s use a multiplex wiring system and cannot be tapped into. Some newer vehicles (e.g. 2011-13 Chrysler products) have a functional brake switch even though the brake lights don’t come on in the towed position. 2014+ Chryslers are only functional for five minutes.

The following instructions are written with a labor-saving installation method of the monitor light. A wireless radio set is also available (PN 9599005). If your system included the Wireless Coachlink, please follow the instructions included with the Wireless Coachlink. Contact the Demco Help Line for specifics if needed.

*All parts needed for this step are located in the “Coach Notification Kit”

1. Decide on a location for the LED strip. The provided LED strip is extremely bright and can be placed in any location on the towed vehicle that is viewable in the rear camera of the coach. Many have found that the back side of the rear view mirror provides a good backdrop for the LED and is easily viewable in the coach’s rear camera. The following steps are written with this in mind.
2. Using the provided double sided tape fastener, attach the LED to the rear view mirror of the towed vehicle.
Note: During tow it may be helpful to angle the rear view mirror toward the rear camera of the coach.
3. Conceal the wires by routing it along the top of the windshield and down the side of the A-pillar on the driver’s side of the towed vehicle. The A-pillar can be removed if needed, but exercise caution as some models have side curtain air bags. Most A-pillar covers are secured with 1-2 screws (in the handle area) and hidden pop connectors. Remove the screws and gently pull the cover away from the pillar. Note: It may be necessary to extend the wires of the LED.
4. Locate the cold side of the brake light switch (BLS). This is the wire that is normally cold, but has 12v+ when the brake pedal is depressed.
5. Crimp the spade onto the red wire on the LED and place the spade into the flip-over connector.
6. Clip the flip-over connector onto the cold side of the brake light switch wire.
7. Using the provided 3 way crimp connector, connect the Black wire from the LED to the Black wire on the G-Force Controller that was mounted in Step 3.

* Careful attention must be given to disabling the light before driving the towed vehicle on public streets. In this configuration, the toggle switch will disable/enable the light.

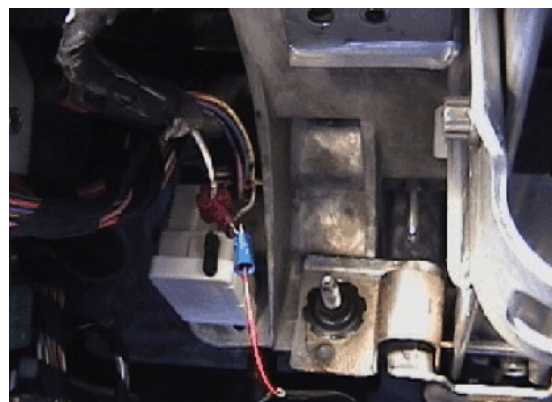

Step 5: Go Through the Fire wall

Concerns:

- Exercise extreme care if you make an additional hole in the fire wall.
 - Stay clear of any existing wiring, heat source, sharp edges, etc.
 - Any openings made in the fire wall must be plugged with an appropriate sealant to ensure that no fuel or exhaust fumes can enter the passenger area of the towed vehicle.
1. Locate an existing access of sufficient size through the fire wall to accommodate the G-Force Controller wire and the air hose. Almost all towed vehicles will have such an access available, but, if not, you may need to drill a hole. In many cases, if an existing grommet hole is not available, a small opening may be made in the car's main wire harness grommet. Be sure to stay clear of the car's wiring.
 2. Pass a straightened coat hanger or fish tape into the engine compartment from the inside of the vehicle. In the passenger compartment, insert the coat hanger or fish tape two to three inches into the air line and wrap it, along with the G-Force Controller wiring, with electrical tape so that the assembly is as streamlined as possible. Apply spray silicone or dish soap and gently pull it into the engine compartment through the opening.



3. Pull out excess slack.
4. Route the airline to the Operating Unit and connect it to the air bulkhead.
 - A. Cut the air hose using an appropriate hose cutter. Make sure the cut is straight. Air leaks can exist if the air hose is not cut straightly.
 - B. Push the air hose in all the way. These fittings are tight, and the hose will snap into place with **two** "clicks."

Note: Should you find it necessary to remove an air hose, push the air hose in with one hand, push on the outside ring of the pushlock connector with the other hand, and then pull the air hose out. The ring will release the air hose.

Step 6: Mount the Cylinder

Special attention must be given to vehicles with adjustable pedals. Check for proper clearance in all positions. When adjusting the cable, be sure that the pedals are positioned closest to the driver's seat. This will allow normal operation of the adjustable pedals. Be sure to return the pedals closest to the driver's seat when preparing to tow, or the braking system will not function properly. As an option, the pedals may be moved to the desired position and disabled. **Do not depend on the fact that "no one moves them."**

1. Find a location on the brake arm that will position the cylinder as low as possible but as high as necessary not to interfere with normal driving. The higher the cylinder is mounted, the less effective it is. Note: Some vehicles are equipped with a "hush panel" under the dash which may need to be removed or modified. The cylinder should be about 1-2" above the driver's foot location while operating the vehicle. Remember, during normal operation the brake pedal is depressed with the ball of the foot.
2. Position the actuator. Place the actuator on the brake arm, slide the backplate over the bolts, and position the actuator so that the brake arm is in the middle of the bracket. Loosely thread the nuts on the bolts. The actuator should be mounted so that when the brake pedal is depressed about two inches the actuator is perpendicular to the fire wall. This equates to about 1 inch above straight in line (See Fig 14.1). Now tighten the nuts finger tight to temporarily hold the actuator in place. Take note of the distance between the actuator and the anchor, this distance should be at least 3 1/2" - 4" or more, this allows the cable to naturally coil and uncoil under normal driving. You can flip the bracket on the actuator 180° to gain more distance, see Fig. 14.3. Note: Be sure to cut away any sound deadening material before attempting to mount the clamp.



SCAN CODE HOW TO INSTALL ACTUATOR



Cable breakage can only occur if there is an improper angle or if the cable is overtightened in the anchor. Review this step carefully after the cylinder is mounted to ensure proper installation. Also make sure there is a minimum of 3 1/2" - 4" between the end of the cylinder and the anchor when brake pedal is released.

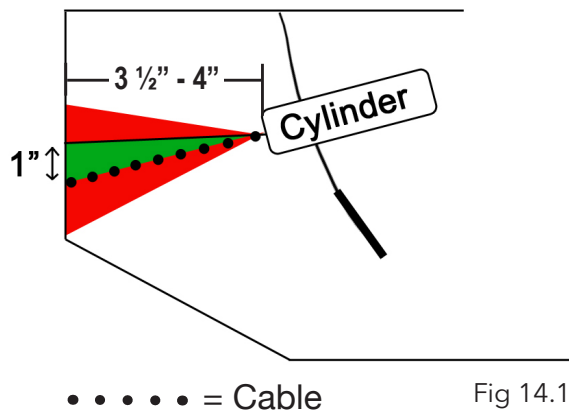

Fig 14.1

3. Mark the anchor location on the fire wall, **BE SURE THIS LOCATION IS NOT DIRECTLY BEHIND THE BRAKE BOOSTER**. Thread the cable through the anchor and position the anchor on the fire wall so that the cable has a direct line to the actuator throughout the swing of the brake arm. Once the location is determined go ahead and remove the slack in the cable leaving about 1/4" - 1/2" of slack. Hold the cable in place, thread the cable around and through the anchor causing it to be "double looped" (Fig 14.2), and tighten the set screw to **15 inch-pounds**. (About 1 full turn after contact). The amount of slack has no effect on the amount of pressure or proportionality of the systems. It only reduces the available stroke of the actuator. Excessive slack will result in premature wear of the actuator cable. Important: The set screw has teeth designed to grip the cable preventing slippage. Depending on the wrench used it is possible to over-tighten and damage the cable. Keep in mind that with a 5" wrench only 3 lbs of force is required, with a 7.5" wrench only 2 lbs., etc.

Fig 14.2

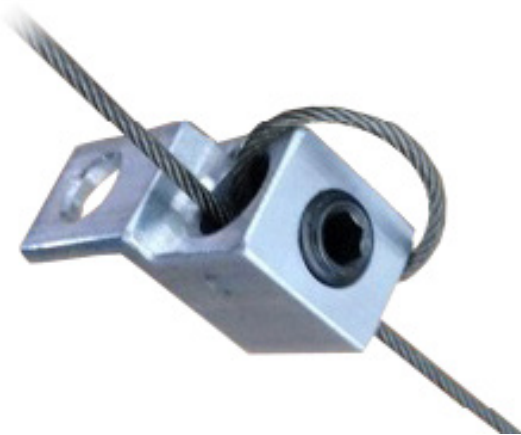
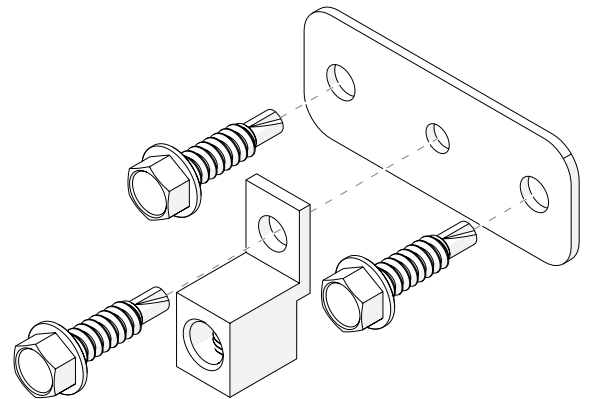

Fig 14.2.1



4. Using the provided self-drilling screw mount the anchor to the fire wall. Visually verify from the engine side of the fire wall that the proposed location is acceptable for the self-drilling screw. Often, a small pilot hole can be helpful in verifying the location. Mount the clamp. If the fire wall is found to be too thin to properly secure the anchor, a nut and bolt may be needed to firmly secure the anchor or use the included reinforcement plate and self-drilling screws as shown in figure 14.2.1.

5. Secure the Actuator. Verify that there is still only 1/4" - 1/2" of slack in the cable. It may be necessary to move the actuator forward or backward if the amount of slack changed during fitment. Tighten the bolts in a cross pattern until the backplate begins to bend around the brake arm. This will "lock" the nuts and keep them from loosening Figures 14.3 & 14.4 & Fig 14.5 on the following page.

6. Route a length of 1/4" DOT air line from the cylinder to the Stay-IN-Play Duo Unit and connect it to the pushlock connector labeled "Air Out".

Fig 14.3

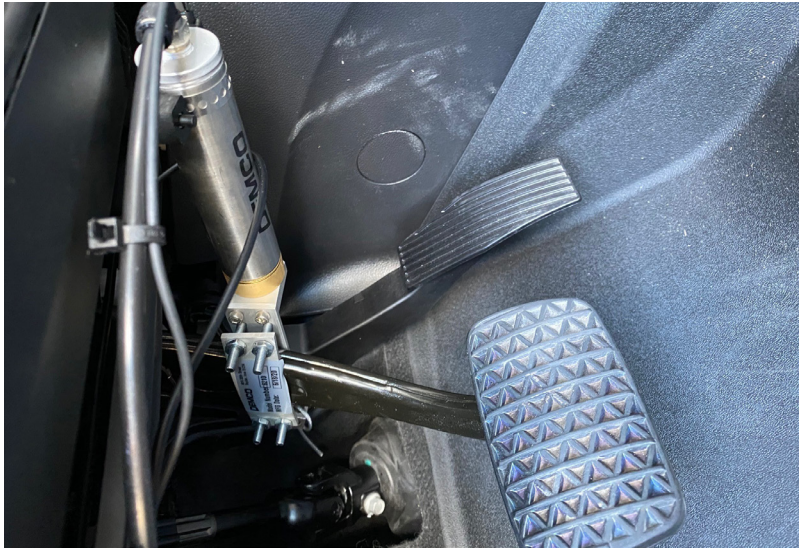

Fig 14.4



Fig 14.5



*Cable breakage can only occur if there is an improper angle or if the cable is overtightened in the anchor. Review this step carefully after the cylinder is mounted to ensure proper installation. The actuator cable is a stranded steel aviation cable with a tensile strength of 460lbs. The actuator is mechanically unable to break the cable by force.

Step 7: Mount the Breakaway Switch

1. Mount the breakaway switch to the front of the towed vehicle as close to the center of the towed vehicle as possible using the provided hardware. In many cases it can be mounted to the front fascia in a manner that allows it to turn 90° when not in tow. NOTE: Use 1/2" flex wrap to protect wiring from breakaway switch.



Step 8: Making the Electrical Connections

Note: Pull on each wire after the connector is applied to be certain it is secure.

1. Cut fuse holder loop in desired location. Connect the red fuse holder to the battery or a hot terminal in the fuse block. **DO NOT PUT THE FUSE IN.**
2. The brown wire from the Operating Unit and the orange wire from the breakaway switch attach to the red fuse holder using the three-way crimp connector.
3. The blue wire from the Operating Unit attaches to the black wire from the breakaway switch.
4. The white wire from the G-Force Controller II attaches to the white wire of the tow wiring **AND** to a suitable ground (preferably not the battery). **Correct Grounding Is Essential.**
5. The red wire from the Operating Unit attaches to the red wire from the G-Force Controller II.
6. The black wire from the Operating Unit attaches to the black wire from the G-Force Controller II.

Note for 7 & 8

This installation assumes your tow wiring is based on a standard 4-wire connection from the motor home. If you have a separate wire for the brake signal from the motor home (amber turns on the towed and coach), find the wire that receives 12v (+) when the brake pedal of the coach is depressed. That is the wire that the green and yellow wires are to be attached to.

7. The green wire from the G-Force Controller attaches to the green wire of the tow wiring (see note below).
8. The yellow wire from the G-Force Controller attaches to the yellow wire of the tow wiring (see note below).

Note: If the tow wiring harness is not diode protected please add supplied diodes using butt connectors supplied to yellow and green circuits between the connections made in step 7 & 8 and the rear tail light bulbs.

9. Insert the 20 amp fuse into the fuse holder.

Step 9: Connect the Cylinder Air Line

Connect the cylinder air line to the Operating Unit using the same method found in "Step 5-4."

Step 10: Making the Vacuum Connection

First, locate the vacuum line coming from the brake booster and determine its size. Then, select from one of the following options.

Note: This portion of the installation is for vehicles with vacuum-assisted brakes ONLY. If you have hydro-boost brakes simply leave the vacuum line and check valve at the Duo operating unit open to atmosphere. If you have an electric brake assist and your vehicle requires the battery to be disconnected, leave the vacuum line and check valve open to atmosphere. If you have electric brake assist and the battery remains connected, remove the check valve, and turn it around or block off the vacuum check valve. If you are uncertain of your vehicle's braking configuration, call the Demco Help Line 800.543.3626 for assistance.

On Turbo charged vehicles, make your connection between the factory check valve and the vacuum brake booster.

On most newer vehicles 2010+, you will find a vacuum sensor at the brake booster. On 2015+ Ford vehicles, the brake booster will have two vacuum ports, one for the vacuum line and one for the vacuum sensor. In these situations, you can use the Demco part # 6257 connected directly to the brake booster. On the 2015+ Ford vehicles, it is best to install it in the sensor port. Contact the Demco Help Line for details.

SPECIAL CONCERNS

1. Special care must be given to installing the engine check valve in the proper orientation. (Motor, Unit Check Valve [black/white], Tee, Booster). Fig 12.2
2. Exercise care in routing the hose so that no kinks, sharp edges, heat, etc., will effect the operation of the system.
3. Lubricate the check valve and tee with a small drop of dish soap or silicone spray. This will help them slide easily into the vacuum hose. Only make clockwise movements with the check valve or it may come apart.

Fig 12.1

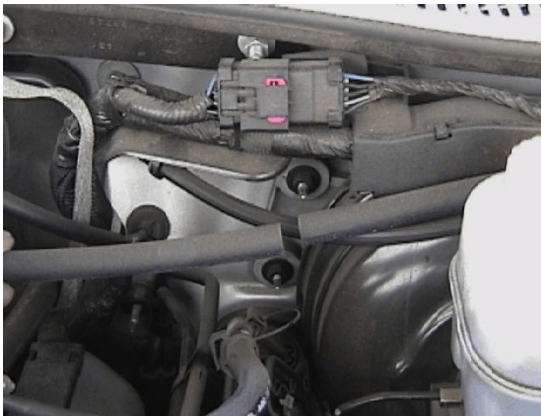
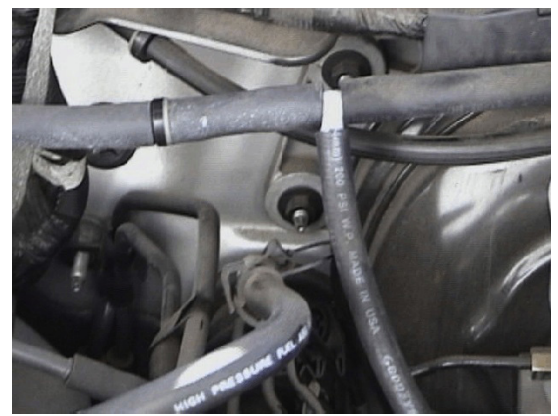

Fig 12.2



SCAN CODE HOW TO MAKE YOUR VACUUM CONNECTION

1 1/32-3/8 I.D. HOSE SIZE (does not require hose clamps)

1. Locate the existing vacuum hose and determine where the check valve and the tee will be inserted into the hose.
2. Cut the existing hose where the check valve will be inserted and install the check valve. Take care not to cut too close to a bend in the hose that will not allow the check valve to be inserted fully into the hose. (Black end toward the motor).
3. Cut the hose where the tee will be inserted and install the tee. Take care not to cut too close to a bend in the hose that will not allow the tee to be inserted fully into the hose.
4. Route the hose coming from the operating unit to the location where the tee will be installed. (Stay away from sharp edges, heat sources and kinks).
5. Cut the hose coming from the Demco unit to the proper length and slide onto the tee. Make sure enough excess is left to avoid kinks.

HARD PLASTIC VACUUM LINES:

1. Cut a two inch length of hose from the provided 3/8" vacuum hose and slide one end onto the white end of the check valve. Insert the tee into the other end.
2. Cut another two inch length of hose and insert the open end of the tee into it (the open end of the hose will slip over the smaller hard plastic tubing). Cut another two inch length of hose and insert the open (black end) of the check valve.
3. Cut out a portion of the existing hard plastic tubing and slip the open ends of the hose and hose clamps over the plastic tubing. Make sure the black end of the check valve is toward the motor.
4. Put the enclosed clamps on the hose that the hard plastic tubing is inserted into (do not overtighten).
5. Cut the hose coming from the Demco unit to the proper length and slide onto the tee. Make sure enough excess is left to avoid kinks.

Fig 13.1



TOWED VEHICLE INSTALLATION

1/2-5/8 I.D. VACUUM LINES

1. Cut a two inch length of hose from the provided 3/8" vacuum hose and slide one end onto the white end of the check valve. Insert the tee into the other end.
2. Cut another two inch length of hose and insert the open (black) end of the check valve. Slide the hose adapter into the other end.
3. Cut another two inch length of hose and insert the open end of the tee into it. Slide the other hose adapter into the other end.
4. Cut out a portion of the existing larger vacuum hose out and slip adaptors and hose clamps into the open ends of the hose. Make sure the black end of the check valve is toward the motor.
5. Cut the hose coming from the Demco unit to the proper length and slide onto the tee. Make sure enough excess is left to avoid kinks.

Fig 13.2



Step 11: Testing the Install

1. Turn on the toggle switch.
2. If coach notification light is connected to the vehicle stop switch, push the brake pedal down in the towed vehicle. The notification light will illuminate. If not, check the brake-light switch connection and the ground connection.
3. Remove the breakaway pin and observe the operation of the cylinder. Note the cable attached to the fire wall. It should be as close to an inch above being straight with the cylinder as possible (see FIG 14.1 page 10). When it is in this location, the cable will be straight with the cylinder when the brake pedal is in the down position. The air pump will run continuously, and apply the brakes of the towed vehicle. As the pump runs, more brake effort is applied to the towed vehicle until the maximum effort is reached. Let the pump run for about 10 seconds and replace the breakaway pin.
4. Verify that the brakes in the towed vehicle are fully released. Inspect the cable clamp and verify the cable has not slipped in the clamp.
5. Tape all electrical connections with a high quality electrical tape, and use cable ties to secure the wires.
6. With the G-Force Controller knob at the bottom of the slot, go to the coach and press on the brake pedal. The tow wiring must be connected. **Do not connect the tow bar.** Confirm the activation of the system by checking the light in the back up monitor. If the system fails to activate, refer to Step #12-1 and re-test.

Step 12: Adjusting the G-Force Controller

Note: The Stay-IN-Play Duo's activation is progressive in nature. It is designed to activate briefly in normal stopping (20+ MPH) and longer in harder/panic stopping. **When adjusted correctly, the Stay-In-Play WILL NOT activate while stationary.**

1. Locate the vehicles on level ground and turn the switch to "ON." Place the black knob on the G-Force Controller at the bottom of the slot and have an assistant step on the brake pedal of the coach. At this point the system should activate. If it does not, remove the front mounting screw from the G-force Controller and lower it until the unit activates and then re-secure it in this location. Slowly raise the knob up. The system may begin chattering, keep raising the knob. As soon as the pump shuts off completely and then go up another 1/8". Tighten down the black knob to ensure it does not move.
2. Test drive the coach while pulling the towed. Drive and stop **NORMALLY** as these are the conditions for which you want to configure the braking system. The system should not come on in normal stopping below 20 mph.
3. If while traveling the system activates too often, raise the knob 1/16". Repeat step 2.
4. If while traveling the system doesn't activate often enough, lower the knob 1/16". Repeat step 2.

*The Stay-IN-Play Duo system operates the brakes of the vehicle in the same manner as you would. The more often it comes on, the more quickly the brakes of the vehicle will wear. The above adjustment will equal normal driving mileage on the brakes.

Step 13: The Breakaway Cable

Clip the breakaway cable to the hitch-receiver tow-cable holes on the coach and clip the lanyard to the loop on the breakaway plug. The length of the cable should be long enough that it will not pull out on the tightest possible turns made in either direction. Also route the cable so that it will not get caught on the tow bar. It should be short enough that it will pull out before the towed reaches the end of the safety cables.



SCAN CODE HOW TO PROPERLY ADJUST THE G FORCE CONTROLLER

TROUBLESHOOTING

At Demco we exercise great care in building and packaging your unit. All operating units are thoroughly bench tested before being shipped. We encourage you to contact our Help Line any time you have questions about the installation or operation of your Demco Vacuum-Assisted Brake.

AIR PUMP

Air Pump will not shut off:

1. Check to see that the breakaway pin is secure.
2. If the pump continues to run call the Help Line 800.543.3626.

Actuator not moving brake pedal:

1. Check cable tension (Step 6).
2. Remove actuator air line and check for pressure. If there is no/weak pressure check line for a pinch, kink, or puncture.
3. If no issue is found call the Help Line 800.543.3626.

WIRING

Check the fuse and the holder at the battery and the WHITE wire connection. Also, be sure that the 20-amp fuse is installed in the fuse holder.

Unit failed to operate when the RV brakes were applied:

1. Be sure the toggle switch is in the on position. Using a voltmeter or a test light, determine if there is 12v (+) between the brown wire and the black ground wire at the Operating Unit. There should be 12v (+) between these two wires at all times, when the switch is on.
2. Check the orientation of the G-Force Controller. It may need to be tipped slightly forward.
3. Check continuity from the white wire to the frame. If there isn't continuity, reground the white wire to the frame of the towed vehicle.
4. With the RV brakes applied check for 12v (+) between the Demco GREEN wire and the Demco BLACK wire. If no or low voltage is present, check the scotch lock connection to the towed vehicle's tow wiring. Remember the 12v (+) for this is coming from the coach. Check to see that the coach is grounded properly to the car in the tow wiring.
5. Apply the RV's brakes with the tow wiring connected. Lower the knob on the G-Force Controller. If you check the voltage and the unit still does not operate, call the Help Line 800.543.3626.

Breakaway failed to operate the brakes:

1. Make sure the toggle switch is turned on.
2. Remove the breakaway plug from the front of the towed vehicle. Test for 12v (+) between the blue wire and the black wire on the Operating Unit. There should be a 12v (+) at that time, and ONLY then. If not, check continuity to ground with the black wire. Check the connection at the battery and the fuse. Check the connection of the blue wire.
3. Turn off toggle switch. Clean breakaway switch by spraying contact cleaner or spray silicone into switch and pull the pin in and out 3-5 times. It may be necessary to use a fingernail file between the points if the switch is especially corroded. Inspect the O-ring on the lanyard-side of the pin to prevent future corrosion.

Unit pulsates with turn signals:

1. Unit sensitivity is too low. Refer to Step 12 to set the sensitivity.
2. Be sure that the G-Force Controller is level and properly oriented (Step 3).

What now?

If the problem has not been solved, you will need technical assistance from Demco Manufacturing, Inc. Call us at 1-800-543-3626.

After installation, the brake does not apply while stationary:

1. The Stay-In-Play DUO's activation is progressive in nature. It is designed to activate briefly in normal stopping (20+ MPH) and longer in harder/panic stopping. **When adjusted correctly, the Stay-In-Play DUO WILL NOT activate while stationary.**

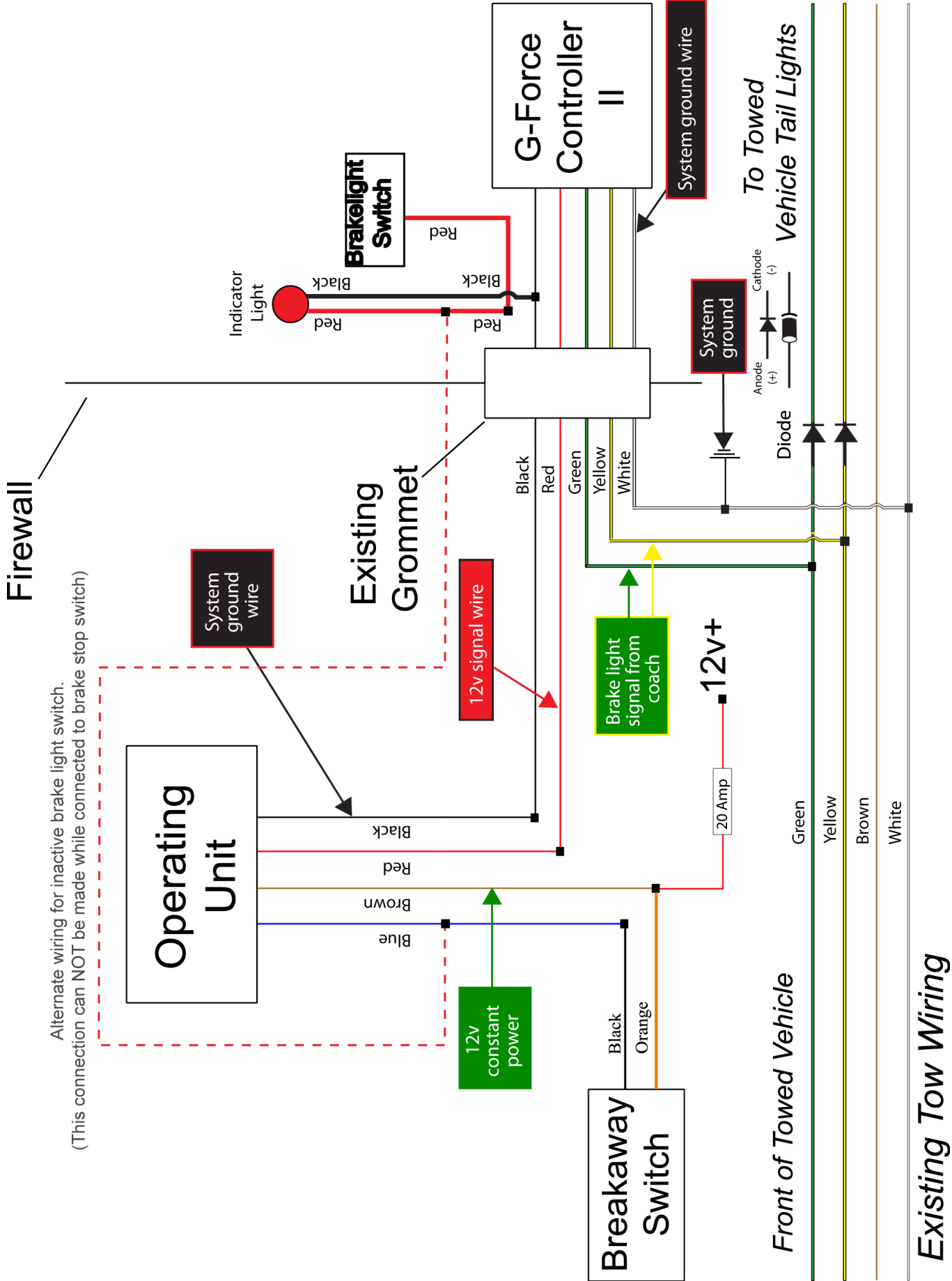

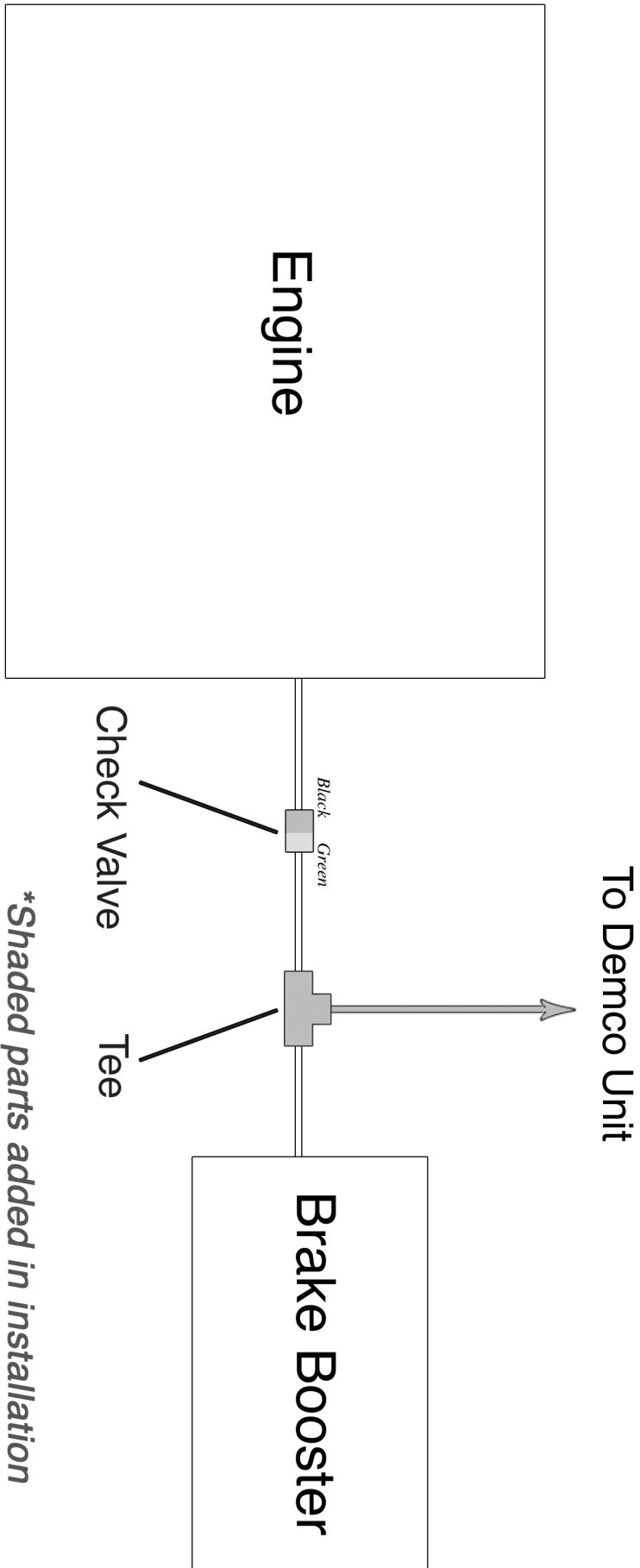

Limited Five (5) Year Warranty

We are confident that our product will perform well and therefore warrant the original purchaser, that the new product will be free from mechanical and electrical defects in material and workmanship during the warranty period. The Warranty period begins on the original purchase date. The warranty is for current production models and the original purchaser only. Demco does not warrant any part of the installation nor failure related to improper installation.

The Warranty Period

1st Year

If, during the first 12 months of the warranty period, your Demco product should be found defective, Demco will repair or replace the product at its discretion. Demco will refund to the original purchaser freight charges incurred in returning the product to the factory during this portion of the warranty period. (This does not include repackaging charges incurred to a third party). All warranty shipping & freight charges are for normal delivery, expedited freight charges are not included. Demco may choose, at its sole discretion, to allow usage of other new parts for the purpose of warranty repair. Such approval requires prior authorization and is subject to the return authorization policy.

Labor pertaining to warranty repair will be covered with prior approval from Demco and is subject to the return authorization policy. Warranty performed prior to approval will be reviewed and assessed by Demco on a case by case basis.

2nd - 3rd Year

If, during the 2nd through the 3rd year of the warranty period, the Demco product should be found defective, Demco will, upon receipt of post prepaid product, repair or replace the product at its discretion. The Demco product will be returned via standard delivery free of charge.

Outside labor pertaining to warranty repair is not covered.

4th - 5th Year Extended Warranty

In order to receive 4th and 5th years of warranty, the Demco product must be registered within 30 days of purchase. Consideration for special cases may be addressed on a case-by-case basis at Demco's discretion. If, during the 4th and 5th years of warranty period, the Demco product should be found defective, Demco will, upon receipt of post prepaid product, repair or replace the product at its discretion. Demco reserves the right to charge for labor on required repairs of the Demco product depending on condition of the product received. Customer will be responsible for return shipping during this portion of the warranty period.

Outside labor pertaining to warranty repair is not covered.

What is Not Covered

Our warranty for your product will not cover damage resulting from set-up for towing, installation, neglect or misuse, use contrary to operating instructions, charges associated with removal/replacement of components, distortion and/or damage caused by either or heat, or disassembly, repair, or alteration by any person other than an authorized service center. Any implied warranty of merchantability or fitness for a particular purpose of your product is limited to the duration of this written warranty. We shall not be liable for any incidental or consequential damages for breach of any express or implied warranty.

Your State Laws

Some states do not allow limitation on how long an implied warranty lasts or the exclusion or limitations of incidental or consequential damages, so the above may not apply to you. This warranty gives you specific legal rights, and you may also have other rights, which vary from state to state.

DEMCO

4010 320th St., Boyden, IA. 51234

Phone: (712) 725-2311

Fax: (712) 725-2380

Toll Free: 1-800-54DEMCO (1-800-543-3626)

**Demco warranty policies, operator manuals, and product registration
can be found online:**

www.demco-products.com