

A blue pickup truck is shown from a side-rear perspective, towing a white trailer. The truck is parked on a dirt or gravel surface. The trailer has a silver metal frame and a white door. The background shows some green foliage.

**DEMCO**

COMPLETE RV AND  
TRAILER COMPONENTS CATALOG

**TOWING**  
SOMEWHERE?

CLICK ON PHOTO ABOVE TO MOVE TO THAT SECTION IN THE CATALOG



### **Our Story**

*Back in 1950, Robert Dethmers started Dethmers Manufacturing Company in a corner of an implement dealership. One of his first products was fertilizer application equipment for the agricultural industry.*

*Since the beginning, Demco has pursued a dream to fill needs, provide solutions, and compete in an existing marketplace. Demco has product lines in agriculture, towing, 5th wheel hitches, trailer components, Rental Industry, and semi trailers. Demco has earned its place with the right combination of skill and technology needed to produce the best products available without compromise.*

*Today, as Demco continues to grow, our tradition of building quality products, employing talented, industrious people and providing attentive service remains. Our sales staff, along with our dealers and distributors across the United States, Canada and the world, carry on the standard.*

*We enjoy long-term relationships with our clients and look forward to this continuum with our new clients.*



### **RV PRODUCTS**

- Supplemental Braking Systems ..... 4-5
- Tow Bars ..... 6-7
- Baseplates ..... 8
- Tow Dollies..... 9
- Tow Dolly Accessories..... 10
- Towed Connectors ..... 10-11
- 5th Wheel Hitches, OE adapters and accessories ..... 12-16
- 5th Wheel Mounting Brackets List ..... 17

### **TRAILER COMPONENTS**

- Brake Actuators ..... 19-33
- Couplers ..... 34-43
- Tongues..... 44
- Brakes and Brake Line kits ..... 45-49
- Spare Tire Mounts ..... 50

MFG	SYSTEM	5 YR WARRANTY	DUAL SIGNAL	PROPORTIONAL BRAKING	INSTALLED	PORTABLE
Demco	AFO	✓		✓	✓	
Demco	SIP DUO	✓	✓		✓	
Demco	Delta Force	✓	✓	✓		✓

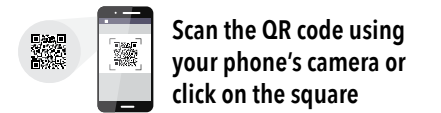

AFO with Wireless Coachlink  
Air Force One Braking System  
Air Force One, Second Car Kit\*  
AFO Reinstall Kit

9599019  
9599007  
6271  
6217

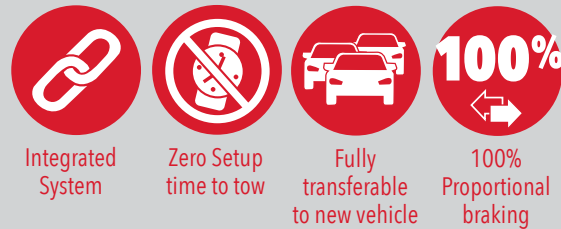

### WHY AIR FORCE ONE

- Engineered for diesel RVs with air brakes
- Demco-exclusive integrated breakaway system
- Meets chassis warranty & Federal D.O.T. / FMVSS requirements
- Patented actuator helps your RV and towed vehicle brake as one



US Patent 7,699,406



DUO with Wireless Coachlink  
Stay in Play Duo Braking System  
DUO Reinstall Kit

9599018  
9599006  
6270



### WHY STAY-IN-PLAY DUO

- Engineered for gas RVs with hydraulic brakes
- Demco-exclusive integrated breakaway system
- Unique dual-signal activation
- G-Force controller lets you adjust braking power
- Patented actuator helps your RV and towed vehicle brake as one



US Patent 6,644,761



Delta Force Braking System  
Delta Force 2nd Car Kit

9599004  
6221

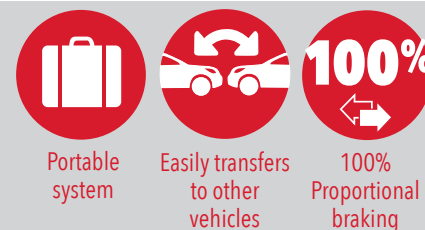

### WHY DELTA FORCE

- Engineered for both gas and diesel RVs
- Set it Once pedal clamp
- Up to 75% smaller than other portable systems
- Features Coachlink wireless notification system

75% smaller than competitor models



STOP YOUR COACH  
FASTER!

RESULTS FROM  
60 MPH\*

No Demco System  
250-280 Feet

With Demco Systems  
170-205 Feet

\*Approximate distances. Actual stopping distances will vary.



### SUPPLEMENTAL BRAKING SYSTEM ACCESSORIES

PART DESCRIPTION	PART #	PART DESCRIPTION	PART #
<b>Stand Off Bracket for Delta Force</b> Gives extra 2" of space between the box and brake arm connection	6274	AFO - DUO Conversion Kit	6218
<b>Smart Car Bracket</b> For DUO and AFO	6227	DUO - AFO Conversion Kit	6220
<b>Vacuum Tee Kit</b> For DUO and AFO	6257	AFO Second Car Kit	6271
Standard AFO Coiled Airline	6212	Delta Force Second Car Kit	6221
Spartan (Safe Haul) Specific Coil Airline	6296	AFO reinstall Kit	6217
Freightliner (Brake Sync) Air Jumper	6376	DUO Reinstall Kit	6270
AFO Air Pressure Stop Switch	6232	Coach Air Kit	6231
Replacement AFO Air Cylinder	6210	Battery Disconnect Switch	6338
Replacement DUO Air Cylinder	6215	SBS Air Tester	6339
		12V Power Outlet	6342
		Jeep Brake Arm Bracket	6356

### WIRELESS COACHLINK™

Universal for all Braking Systems

- Plugs into coach power port
- Instant visual feedback that brakes are applied
- Transmits signal from towed-vehicle

- Positive "Brakes on" light
- Audible tone indication lets you know your braking system is working flawlessly

Wireless Radio Set

9599005



## YOU ASKED, WE LISTENED

Now order with or without Wireless Coach notification!

AIR FORCE ONE & STAY-IN-PLAY DUO



WIRELESS COACH NOTIFICATION INCLUDED



**Make Towing Easy**  
**TRY OUR ONE HAND CHALLENGE**

Patent # 6502847, 6612604, 6764092, 7837216

## DEMCO DOMINATOR™



**LIGHTWEIGHT**

**9511008 - Dominator™**

Weighs: 30 lbs.  
Tows: 7,500 lbs.

## DEMCO COMMANDER™ 2



**ECONOMICAL**

**9511012 - Commander 2™**

Weighs: 41 lbs.  
Tows: 6,000 lbs.

## DEMCO EXCALI-BAR™ 3



**HEAVY DUTY**

**9511013 - Excali-Bar 3™**

Weighs: 46 lbs.  
Tows: 10,500 lbs.



LIMITED  
WARRANTY  
LIFETIME



Self-supporting  
arms



SAFETY  
Safety cables  
included



Easy trigger  
release

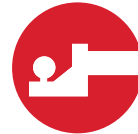

Rise or drop  
male receiver



Adjustable  
towing angle



MADE IN  
USA

## SENTRY DEFLECTOR™



Strong but  
lightweight  
and flexible

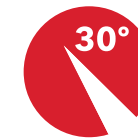

30°  
Deflect debris  
away from  
vehicle



Easy to install  
and remove

Tow Bars - 9523135

Tow Dollies - 5950

## TOW BAR ACCESSORIES

PART DESCRIPTION	PART #	PART DESCRIPTION	PART #
<b>TOWING COMBO KITS:</b>		<b>SAFETY CABLES:</b>	
<b>Diode System Combo Kit</b>	9523057	54" Straight Safety Cables *	9523051
Kit includes: 6 Way Coiled Lighting Cable, Diode Wiring Kit, Marine Grade, Vinyl Demco Storage Cover, Three Pin Locking Kit, 7 to 6 Way Adapter		64" Straight Safety Cables *	9523055
<b>Bulb/Socket Combo Kit</b>	9523058	86" Coiled Safety Cables *	9523003
Kit includes: 6 Way Coiled Lighting Cable, Bulb & Socket Wiring Kit, Marine Grade, Vinyl Demco Storage Cover, Three Pin Locking Kit, 7 to 6 Way Adapter		12" Safety Cable Extensions *	9523064
<b>WIRING KITS:</b>		18" Safety Cable Extensions *	9523065
Towed Vehicle Taillight Wiring/ Diode Kit	9523010	<b>LOCKING PINS:</b>	
Bulb Taillight Wiring Kit	9523047	5/8" Locking Hitch Pin	9523066
7 to 6 RV Adapter	9523053	Two Locking Baseplate Pins **	9523067
Light Bar	KKLB	Three Pin Locking Kit **	9523068
Diode Kit (4 Diodes)	9523063	Two Quick Pins *	9523045
<b>FLEX-COILED WIRING CABLES:</b>		Two Standard Pins w/ Quick Pins *	9523046
4 Way Coiled Lighting Cable	9523004	<b>ACCESSORIES:</b>	
6 Way Coiled Lighting Cable	9523006	3 1/2" Receiver Extension	9523052
7 to 6 Way Coiled Lighting Cable	9523054	4" Drop/Raise Receiver for Victory Series Tow Bars	9523059
7 to 4 Way Coiled Lighting Cable	9523069	6" Drop/Raise Receiver for Victory Series Tow Bars	9523060
		Tow Bar Storage Cover	9523042
		Pull Ear Covers *	5899
		<b>SENTRY DEFLECTOR ADAPTERS:</b>	
		For Stowmaster™, Blue Ox™ RV mounted tow bars to Roadmaster™ base plate	9523027
		For Blue Ox base plate	9523061

\* Sold per pair

\*\* All keyed alike

**NEW**

## WIRELESS LED LIGHTBAR

6343

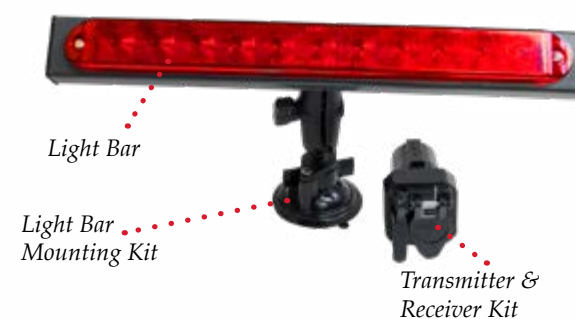

Light Bar

Light Bar  
Mounting Kit

Transmitter &  
Receiver Kit





## Exclusively from Demco – TABLESS BASEPLATES



Available for most current models of tow cars  
**FOR FIT LIST AND AVAILABILITY**  
**SCAN THIS QR CODE** or go to  
**click on the square**



### TABLESS BASEPLATE ADAPTERS

\* Adapts Demco tabless baseplates to other manufacturers' tow bars

PART DESCRIPTION	PART #
Blue Ox Tow Bar (Aval, Aventa, Aladdin, Alpha, Acclaim, Allure)	9523127
Road Master Tow Bar (Falcon 2, StowMaster, StowMaster All-Terrain)	9523128
Road Master Tow Bars: Tracker, Sterling All-Terrain, Black Hawk 2 All-Terrain, Falcon All-Terrain	NO ADAPTER NEEDED

### CLASSIC STYLE BASEPLATE ADAPTERS

\* Adapts Demco tow bars to other manufacturers' baseplates

PART DESCRIPTION	PART #
Roadmaster Baseplates including XL or EZ 2, EZ 4 Series	9523001
Duncan Baseplate	9523017
Reese® Tow Champ & Valley Ind. Utility Tow Bar, Bumper Brackets	9523019
Roadmaster MS, MX, and EZ 5 Series Baseplates	9523032
Blue Ox Baseplates	9523041

### CLASSIC STYLE BASEPLATE ADAPTERS

\* Adapts Demco baseplates to other manufacturers' tow bars

PART DESCRIPTION	PART #
Roadmaster Eagle™ & Eagle 8000™	9523014
Valley Ind. Utility Tow Bar & Reese® Tow Champ	9523015
Roadmaster Falcon 5250	9523023
Blue Ox® Aladden®, Aventa® II, Aventa® LX and Alexis	9523034
Roadmaster Tracker, Falcon 2, Falcon All Terrain, Blackhawk and Blackhawk All Terrain™ and Sterling™ tow bars with serial numbers up to 14,500	9523036
Roadmaster Sterling All Terrain™ & Sterling Tow Bars with Serial #'s above 14,501	9523062

**Custom Chrome Wheels**  
 Radial tires make this dolly one you'll be proud of for years to come

**Durable Galvanized Finish**  
 For years of corrosion free use

**Less than 100 lbs. Tongue Weight When Loaded**  
 For improved ride and handling of towed vehicles

**Tilt-bed Frame**  
 Provides fast, easy loading. Positive locking mechanism on tilt-bed; does not require a separate loose pin

**Hinged Tongue**  
 Hitch folds back to promote minimal storage capacity

**Auto Steer**  
 Steerable axle allows for tighter turns

**Folding Ramps**  
 Ramps fold up to allow for comfortable fit in almost any RV park or garage

Shown: KarKaddy SS



**9713045**  
 Fully extended: 133 inches long  
 Folded: 67 inches long  
 Total towed vehicle weight: 4,800 lbs.  
 Axle capacity: 3,500 lbs.  
 Towed vehicle tread width: 42" min., 76" max.  
 Galvanized finish



**9713093**  
 Fits low profile vehicles  
 Towed vehicle tread width: 42" min., 78" max.  
 Total towed vehicle weight: 4,800 lbs.  
 King pin design swivel platform  
 Black powder coat paint finish with hot dipped galvanized components



Watch this Video on the KarKaddy X:



**Unfolded Kar Kaddy™ SS length is 133"**

Many RV park lots are not deep enough to accommodate your motorhome and tow dolly.



**Folded Kar Kaddy™ SS length is 67"**

By using only half the space, you can fit both the motorhome and tow dolly comfortably in almost any RV lot. Or you can store your tow dolly in front of your car in your garage at home.

# TOW DOLLY ACCESSORIES



# TOWED CONNECTORS FOR DINGHY TOWING

**No Slicing. No Mistakes.**

*The Industry's Best Direct Plug-in Electrical Hook-Up for Your Towed Vehicle*



1. Remove the rear taillights and locate the factory wiring harness at the back of each taillight housing and unplug it
2. Shown is the T-type connectors in the Demco Towed Connector Harness
3. Connect the vehicle factory wiring to one end of the Demco Towed Connector T
4. Plug the other side of the Demco Towed Connector T into the back of the taillight housing
5. Re-install the vehicle taillight and route the rest of the harness up to the front of the vehicle

## WHAT'S INCLUDED

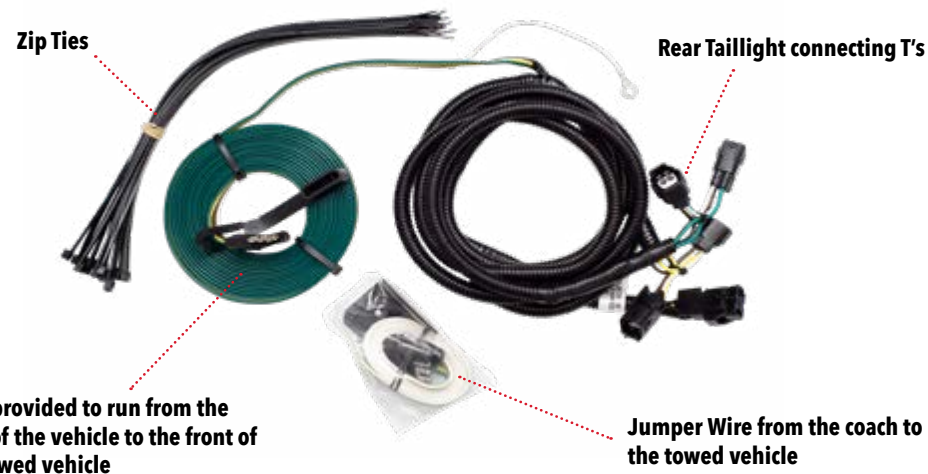

Wire provided to run from the back of the vehicle to the front of the towed vehicle

Jumper Wire from the coach to the towed vehicle

# TOWED CONNECTOR FIT LIST

MAKE/MODEL	YEAR	DESCRIPTION	PART #
<b>BUICK</b>			
Enclave	13-17		9523117
Enclave	08-12		9523141
Rainier	04-07		9523071
<b>CADILLAC</b>			
Escalade	02-06	2 Wheel Drive Only	9523132
Escalade	07-12	2 Wheel Drive Only	9523098
<b>CHEVROLET</b>			
Avalanche	02-06	1500 Series	9523132
Avalanche	07-12	1500 Series	9523072
Cruze	11-15		9523106
Cobalt	08-10	Sport, 2 Dr	9523140
Cobalt	05-10	4 Door No Turbo	9523073
Colorado	04-12		9523074
Colorado	15-21		9523121
Equinox	10-17		9523142
HHR	06-11	No 'SS' or Turbo Models	9523140
Malibu	08-12	No LTZ	9523141
Malibu	13-15	No LTZ	9523108
* Pick-up	07-13	1500 Series	9523132
Sonic Sedan	12-16	Includes Hatchback	9523102
Suburban	03-06	1500 Series	9523132
Suburban	07-13	1500 Series	9523098
Suburban	15-21		9523149
Tahoe	03-06	1500 Series - No Hybrid Models	9523132
Tahoe	07-12	1500 Series - No Hybrid Models	9523098
Tahoe	15-21		9523149
Traverse	09-12		9523141
Traverse	13-17		9523113
Trailblazer	02-08	Including 'EXT' Models	9523071
<b>DODGE</b>			
Ram 1500	09-18	4X4 Only Non LED	9523079
Ram 1500 Classic	19-20	4X4 Only Non LED	9523079
Ram 1500	13-18	4X4 Only With LED	9523114
Ram 1500 Classic	19-20	4X4 Only With LED	9523114
<b>FIAT</b>			
Fiat 500	12-18	All	9523123
<b>FORD</b>			
Edge	07-10		9523133
Edge	11-14		9523136
Edge	15-20	Sport / Titanium	9523150
Escape	08-12		9523133
Escape	13-16		9523110
F-150	09-14		9523133
F-150	15-21		9523151
Fiesta	11-13	Hatchback	9523116
Flex	09-19	All	9523081
Focus	12-18	Sedan	9523138
Focus	12-14	Hatchback	9523139
Fusion	06-12	Includes Hybrid	9523082

*\*Some cutting required*

Fusion	13-20		9523119
Ranger	11		9523133
Ranger STX	05-11	Includes Hybrid	9523133
<b>GMC</b>			
Acadia	07-12	Includes Acadia Denali	9523083
Acadia	13-16		9523117
Canyon	04-12		9523074
Canyon	15-21		9523121
Envoy	02-09	Including 'XLT' and 'XUV'	9523071
Terrain	10-17		9523142
Yukon	07-14	Includes Yukon XL 1500	9523098
Yukon	15-21		9523149
* Sierra	07-13	1500 Series	9523132
<b>HONDA</b>			
CRV	03-06		9523084
CRV	07-11		9523146
CRV	12-16		9523130
Element	07-11		9523086
Fit	09-14		9523147
<b>JEEP</b>			
Cherokee	14-18	Includes Trailhawk	9523134
Compass	11-16		9523107
Liberty	02-07		9523143
Liberty	08-12		9523144
Gladiator	20-21		9523157
Grand Cherokee	99-04		9523089
	05-06	No SRT 8	9523090
	07-13	No SRT 8	9523145
	14-21		9523115
Wrangler	98-06	Including Single & Double Tube Bumper, Rubicon, and Unlimited	9523131
Wrangler	07-18	2018 Jeep JK ONLY	9523129
Wrangler	18-21	JL	9523157
<b>LINCOLN</b>			
MKX	07-10		9523133
MKX	11-15		9523137
<b>MAZDA</b>			
Tribute	08-11		9523133
<b>MERCURY</b>			
Mariner	08-11	Includes Hybrid Models	9523080
<b>OLDSMOBILE</b>			
Bravada	02-04		9523071
<b>PONTIAC</b>			
G5	07-10	2 Door	9523140
G5 Pursuit	05-10	2 Door	9523140
Aura	07-09		9523094
Ion	05-07		9523095
Vue	02-07	No VTI	9523101
Vue	08-10		9523096
<b>SUZUKI</b>			
Grand Vitara	09-12		9523097
<b>TOYOTA</b>			
Rav-4	06-12		9523126

# AUTOSLIDE 13K, 18K, AND 21K 5TH WHEEL HITCHES

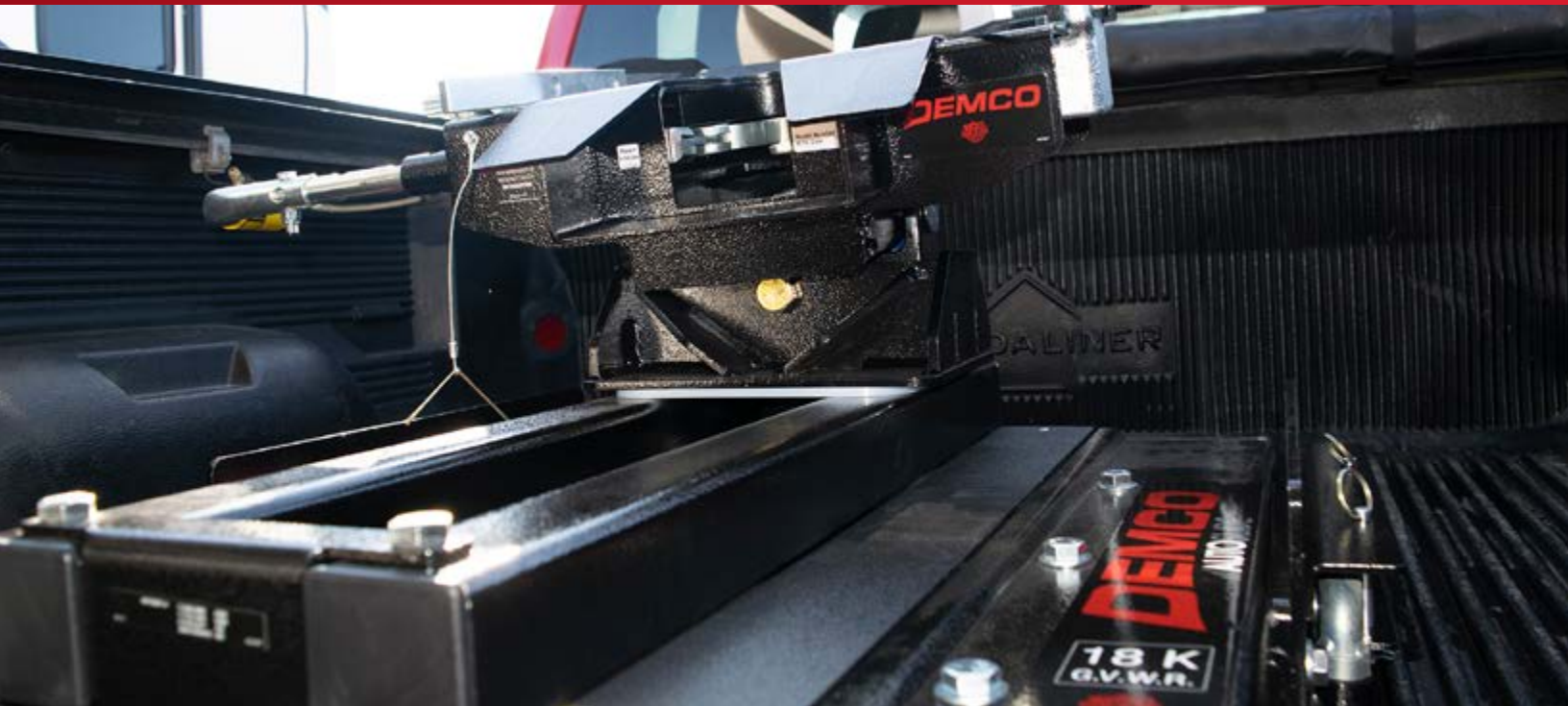

# AUTOSLIDE 13K, 18K, AND 21K 5TH WHEEL HITCHES

18K & 21K Above Bed Mount  
Industry Standard Bed Rails Included

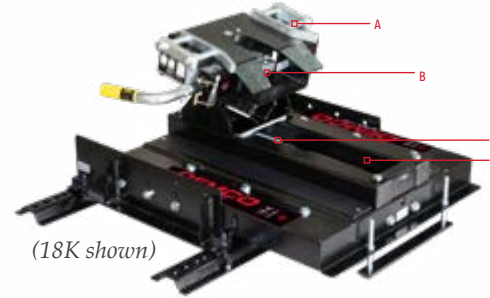

(18K shown)

18K & 21K Above Bed Mount  
Bed Rails NOT Included



(21K shown)

18K & 21K Under Bed Mount  
(UMS)

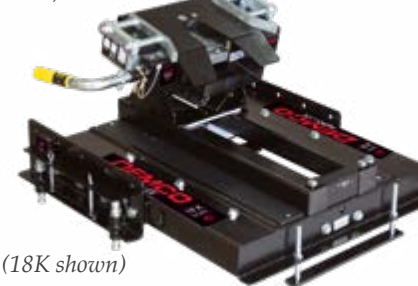

(18K shown)

- A. **No locking plate required** for standard pin boxes to activate slide mechanism
- B. **Wrap around jaw** with locking bar for a smoother, safer and more secure ride
- C. Slides utilizing rack and pinion gear technology
- D. Up to 14" of travel to help get in and out of those tight spots

### Additional Autoslide Information:

- Fits industry standard rails
- Low profile design
- Easy access for routine maintenance
- See 5th Wheel Accessory page for OE prep fits
- 3 vertical height adjustments to help you level truck and trailer
- \* *Frame Mounting Brackets must be ordered separately*
- \* *Need locking plate with Glide Ride, Mor Ryde, Trailair Tri Glide, Trailair Flexair, Rota Flex or 5th Airborne pin boxes*

PART DESCRIPTION	PART #
18K Above Bed Mount Industry Standard Bed Rails Included	8550023
18K Above Bed Mount Bed Rails NOT Included	8550034
18K Under Bed Mount (UMS)	8550022
18K Under Bed Mount (UMS) Ford Prep Package	8550024
21K Above Bed Mount Industry Standard Bed Rails Included	8550036
21K Above Bed Mount Bed Rails NOT Included	8550035
21K Under Bed Mount (UMS)	8550037
21K Under Bed Mount (UMS) Ford Prep Package	8550038

### Locking Plates

For use with Autoslide in conjunction with a pin-box listed below

PART DESCRIPTION	PART #
Lippert Rhino Pin Box	6335
Trailair Tri Glide	6095
Trailair Rota Flex & Trailair Flexair	6171
MOR/Ryde Pin-box	6025
5th Airborne Standard Pin box	6026
5th Airborne Extended Pin box	6062
Demco Glide Ride Pin box	6036
Lippert Turning Point and New 5th Airborne (2020 & newer) Pin box	6285



13K Above Bed Mount  
Industry Standard Bed Rails Included



8550047

13K Above Bed Mount  
Bed Rails NOT Included



8550048

13K Under Bed Mount (UMS)



8550049

- **No locking plate required** for standard pin boxes to activate slide mechanism
- **Wrap around jaw** with locking bar for a smoother, safer and more secure ride
- **22 1/2 INCHES** of travel to help get in and out of those tight spots
- Up to 2 3/4" side-to-side travel to keep your pinbox from hitting bed rails or Tonneau-cover rails
- Industry standard bed rail mounting
- \* *Frame Mounting Brackets must be ordered separately*
- \* *Need locking plate with Glide Ride, Mor Ryde, Trailair Tri Glide, Trailair Flexair, Rota Flex or 5th Airborne pin boxes*

- Adjustable thread shank design to make locking plates more secure in selected position
- Narrowed king pin entry ensures the king pin is centered in the jaws for easier hook up!
- **Maintenance free guide roller** – Lubrication infused bushing
- Teflon wear plates are now wider with beveled edges for smoother turning and transition.

PART DESCRIPTION	PART #
13K Above Mount Industry Standard Bed Rails Included	8550047
13K Above Bed Mount Bed Rails NOT Included	8550048
13K Under Bed Mount (UMS)	8550049

### AUTOSLIDE FACTORY OE 5TH WHEEL PREP ORDERING GUIDE

Truck	18K Auto Slide		21K Auto Slide		+	OEM 5th Wheel Prep Bracket			
	8550024	8550034	8550035	8550038		6099	2016-2019 6194 (6.5' bed)	2016-2019 6200 (8' bed)	2020-2021 6333 (6.5' & 8' bed)
Ford F250/350	✓			✓					
Chevy/GMC 2500/3500		✓	✓			✓		✓	✓
Ram 2500/3500		✓	✓			✓			
Nissan Titan		✓					✓		

(Not needed in a Ford Application)

THE NEWEST MEMBER OF THE RECON FAMILY

NOW IN A SLIDER APPLICATION

**UP TO 14" OF TRAVEL!**



RECON SLIDER 5TH WHEEL HITCH

**DEMCO RECON**

**2** PIECES  
Easy install and removal

**Light weight**

**MADE IN USA**



Recon for bed rails



Recon for Gooseball



Recon for Recessed Gooseball



Recon Slider for bed rails

No additional adapter plates or cables needed to install on a king pin

- Four applications: Stationary and Manual Slider for Industry Standard bed rails, Gooseball mount & Recessed Gooseball mount
- Gooseball mount fits any standard 2-5/16" Gooseneck ball
- Flat deck applications with Recessed Gooseneck ball
- The new Recon Slider allows for 14" of rearward travel
- Wrap around jaw with lock bar for stronger, more secure, safer towing experience
- Dual articulation head for easy hookup and release on uneven terrain
- 3 height adjustments 15-1/2" to 18" for 8550043, 8550044, 8550045
- 3 height adjustments 11-1/2' to 14" for 8550046
- 21,000 towing capacity

PART DESCRIPTION	PART #
ISR Mount (rails not included)	8550043
ISR Mount (rails included)	8550044
2 5/16" Goose Ball Mount	8550045
Flat Deck (recessed 2 5/16" Goose Ball Mount)	8550046
Recon Slider (rails not included)	8550052
Recon Slider (rails included)	8550053



**21K UMS SERIES (UNDER BED MOUNT, FORD PREP & GMC PREP)**

- 21K towing capacity
- Long box application
- Four vertical height adjustments 16" to 19"

8550032 – UMS Series

- Frame mounting brackets must be ordered separately

8550033 – Ford 2011-Present Prep Package

8550050 – Chevy/GMC 2020-Present Prep Package



**NEW**

**31K UMS SERIES (UNDER BED MOUNT FOR CHEVROLET/GMC PREP, FORD PREP, AND RAM PREP)**

- 31K towing capacity
- Long box application
- Four vertical height adjustments 16" to 19"
- Wrap Around Jaw with locking bar for a smoother, safer and more secure ride

8550054 – Ford 2011-Present Factory Prep Install

8550055 – Chevy/GMC 2016-2019 Factory Prep Install

8550056 – Chevy/GMC 2020-Present Factory Prep Install

8550057 – Ram 2013-Present Factory Prep Install

**THE LEADER IN OE ADAPTERS!**

**B&W**

Converts the B&W ball mount to a 21K ISR rail system. Adjustable for bed liners  
\*Not for use with automatic sliding hitches



6140

**Ford 5th Wheel Prep Bracket**

25K rated industry standard rail system for installed 5th wheel prep hitch package



6175

F250 & F350: 2011-2021

**Ram 5th Wheel Prep Bracket**

25K rated industry standard rail system for installed 5th Wheel Prep Hitch Package



6099

2500: 2014-2021  
3500: 2013-2021

**Chevrolet/GMC 5th Wheel Prep Brackets**

21K rated industry standard rail system for installed 5th wheel prep hitch package



6333 for 6.5' & 8' Bed

2500 & 3500: 2020-2021

**Nissan 5th Wheel Adapter**

21K rated industry standard rail system for installed 5th wheel prep hitch package



6200

Titan XD: 2016-2021



6206 for 8' Bed  
6194 for 6.5' Bed

2500 & 3500: 2016-2019



# PREMIER SERIES, SL SERIES, AND ACCESSORIES

# 5TH WHEEL FRAME MOUNTING BRACKET KITS

Bed Rails included. Frame mounting brackets must be ordered separately.



### PREMIER SERIES DOUBLE PIVOT

16K – 8550025      21K – 8550027

- 16K & 21K towing capacities
- Long box application
- Four vertical height adjustments 16" to 19"
- See Demco 5th wheel accessories page for 5th wheel prep truck mounting kits



### SL SERIES DOUBLE PIVOT SLIDER

16K – 8550029      21K – 8550030

- Wrap around jaw with locking bar for a smoother, safer and more secure ride
- Long/Short Box Application 16" to 19"
- 16K & 21K towing capacities
- Double pivot head with polyurethane bumpers
- Four vertical height adjustments
- Upgrade kits available to change with your towing needs

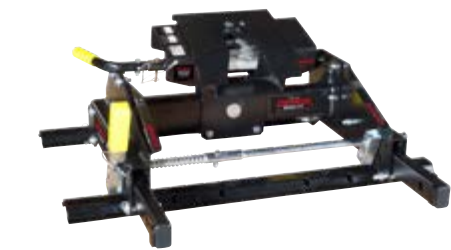

### PREMIER SERIES DOUBLE PIVOT SLIDER

16K – 8550026      21K – 8550028

- 16K & 21K towing capacities
- Short box application
- Four vertical height adjustments 16" to 19"
- See Demco 5th wheel accessories page for 5th wheel prep truck mounting kits



### SL SERIES FLAT DECK

21K – 8550042

- Double pivot head w/ polyurethane bumpers
- Wrap around jaw with locking bar for a smoother, safer and more secure ride
- Long/Short Box Application
- 21,000 lb Towing Capacity

## ACCESSORIES:

PART DESCRIPTION	PART #
<b>Bed Rail Kits</b>	
SL Series Bed Rail Kit	6012
Ultra Series Bed Rail Kit	6014
Premier Series Bed Rail Kit (fits industry standard rails)	6071
<b>5th Wheel Wiring Harness</b>	
7'	8555001
10'	8555002
<b>5th Wheel Upgrade Kits</b>	
Upgrade to a 21K hitch	
Upgrade 8550019 or 8550026 to 21K towing capacity for Premier Series Ultra Slide	6052
<b>Ultra Slide Upgrade Kits</b>	
Upgrade to a manual slide hitch	
Premier Series Ultra Slide Upgrade Kit	6055

**5th Wheel Vinyl Cover**



14844

**Gooseneck Adapters**



SL Series 25K Gooseneck	5992
Premier/Ultra Series 25K Gooseneck	5996
UMS Gooseneck	5988

**Hitch Lifter**



6100

**Make lifting your Demco 5th wheel hitch easier with the hitch lifter. Just snap it into the 5th wheel jaws and use an engine lift or chain hoist to lift your Demco 5th Wheel out of the bed of your truck.**

VEHICLE	YEAR	UMS SERIES UNDER BED MOUNT	PREMIER SERIES	SL SERIES
<b>FORD</b>				
F150 (5 1/2', 6 1/2' & 8' Boxes)	2015-2021	N/A	8552028	8553015
F150 (5 1/2', 6 1/2' & 8' Boxes)	2004-2014	8551001	8552003 or 8552004	8553002
F150 (6 1/2' & 8' Boxes)	1997-2003	N/A	8552009	8553004
F250/350 "Super Duty" (6 1/2' & 8' Boxes)	2017-2021	8551009	8552031	8553017
F250/350 "Super Duty" (6 1/2' & 8' Boxes)	2011-2016	8551000	8552000	8553000
F250/350 "Super Duty"	2005-2010	8551000	8552001 or 8552002	8553001
F250/350 "Super Duty" (6 1/2' & 8' Boxes)	1999-2004	8551000	8552006	8553003
F250 "Light Duty" (6 1/2' & 8' Boxes)	1997-2003	N/A	8552009	8553004
F450 "Super Duty"	2017-2021	8551009	8552031	8553017
F450 "Super Duty"	2011-2016	8551000	8552000	8553000
F450 "Super Duty"	2008-2010	8551000	8552001 or 8552002	8553001
F450/550 "Chassis Cab"	2000-2007	N/A	8552005	Not recommended
<b>CHEVROLET/GMC</b>				
Silverado & Sierra 1500 Crew Cab 5 1/2', 6 1/2' and 8'	2019-2021	8551011	8552034	8553019
Silverado 1500 LD & GMC Sierra Limited Double Cab 6-1/2' Bed	2019-2020	8551008	8552027	8553014
Silverado & Sierra 1500 (5 1/2', 6 1/2' & 8' Bed) Regular, Double, and Crew Cab	2014-2018	8551008	8552027	8553014
Silverado & Sierra 1500 (6 1/2' and 8' Box) (tube frame)	2007-2013	8551005	8552009 or 8552013	8553004
Silverado & Sierra 1500 (5 1/2' Box)	2007-2013	8551008	8552009 or 8552013	8553004
Silverado & Sierra 1500 (6 1/2' & 8' Boxes)	1999-2007	8551004	8552009	8553004
Silverado/Sierra 1500 HD (6 1/2' & 8' Boxes)	2001-2007	8551004	8552009	8553004
Silverado/Sierra 1500 (5 1/2' Box)	2004-2006	8551008	8552009	8553004
Silverado/Sierra 2500 & 3500 HD (6 1/2' box)	2020-2021	8551012	8552037	8553020
Silverado/Sierra 2500 & 3500 HD (8' box)	2020-2021	8551012	8552038	8553020
Silverado/Sierra 2500 & 3500 HD (6 1/2' & 8' box)	2011-2019	8551010	8552011	8553007
Silverado/Sierra 2500 & 3500 HD (6 1/2' & 8' Boxes) (Includes New Body Style)	2001-2010	8551004	8552009 or 8552012	8553004
Silverado & Sierra 2500 (6 1/2' & 8' Boxes)	1999-2007	8551004	8552009	8553004
Silverado/Sierra 3500 (6 1/2' and 8' Box)	1988-2001	N/A	8552009	8553009
<b>DODGE</b>				
Ram 1500 (5 1/2', 6 1/2' & 8' Boxes) No Air Suspension Includes Diesel	2019-2021	N/A	8552032	8553018
Ram 1500 Classic (5 1/2', 6 1/2' & 8' Boxes) No Air Suspension Includes Diesel	2019-2021	N/A	8552030	8553010
Ram 1500 (5 1/2', 6 1/2' & 8' Boxes) No Air Suspension Includes Diesel	2009-2018	N/A	8552030	8553010
Ram 1500 (4x2 & 4x4)(6 1/2' & 8' Boxes)(Includes Mega Cab)	2002-2008	8551005	8552015 or 8552016	8553004
Ram 1500	1994-2001	N/A	8552009	8553003
Ram 2500 (4x2 & 4x4)(6 1/2' & 8' Boxes) (Includes Mega Cab) (Includes Auto Level Rear Air Suspension)	2014-2021	N/A	8552025	8553016
Ram 2500 (4x2 & 4x4)(6 1/2' & 8' Boxes) (Includes Mega Cab)	2013	8551005	8552015 or 8552023	8553004
Ram 2500 (4x2 & 4x4)(6 1/2' & 8' Boxes) (Includes Mega Cab)	2003-2012	8551005	8552015 or 8552016	8553004
Ram 2500 (6 1/2' & 8' Boxes)	1994-2002	N/A	8552009	8553003
Ram 3500 (4x2 & 4x4)(6 1/2' & 8' Boxes) (Includes Mega Cab)	2019-2020	8551006*	8552036	8553013*
Ram 3500 (4x2 & 4x4)(6 1/2' & 8' Boxes) (Includes Mega Cab)	2013-2018	8551006*	8552026	8553013*
Ram 3500 (4x4 only)(6 1/2' & 8' Boxes) (Includes Mega Cab)	2003-2012	8551005	8552015 or 8552016	8553004
Ram 3500 (4x2 only)(6 1/2' & 8' Boxes) (Includes Mega Cab)	2003-2012	8551005	8552017	8553004
Ram 3500 (6 1/2' & 8' Boxes)	1994-2002	N/A	8552009	8553003
Dakota (6 1/2' Box)	2005	N/A	8552019	8553003
Dakota (6 1/2' Box)	2003-2004	N/A	8552005	8553003
Dakota	2002 & earlier	N/A	8552009	8553003
<b>TOYOTA</b>				
Tundra (5 1/2', 6 1/2' & 8' Boxes)	2007-2021	N/A	8552020	N/A
Tundra (6 1/2' & 8' Boxes)	2001-2006	N/A	8552009	Not recommended
Tacoma	2001 & Earlier	N/A	N/A	8553012
T100	2000 & Earlier	N/A	8552009	8553012
<b>NISSAN</b>				
Titan (5 1/2', 6 1/2', 7' & 8' Boxes)	2017-2021	N/A	8552033	N/A
Titan (6 1/2', 7' & 8' Boxes)	2004-2015	N/A	8552021	N/A

Check [www.demco-products.com](http://www.demco-products.com) for latest updates

NO DRILL ATTACHMENT INDICATED IN RED

\*Not with "Auto Level Rear Air Suspension" option



# DEMCO

TRAILER COMPONENTS



## DEMCO ACTUATORS

# DEMCO

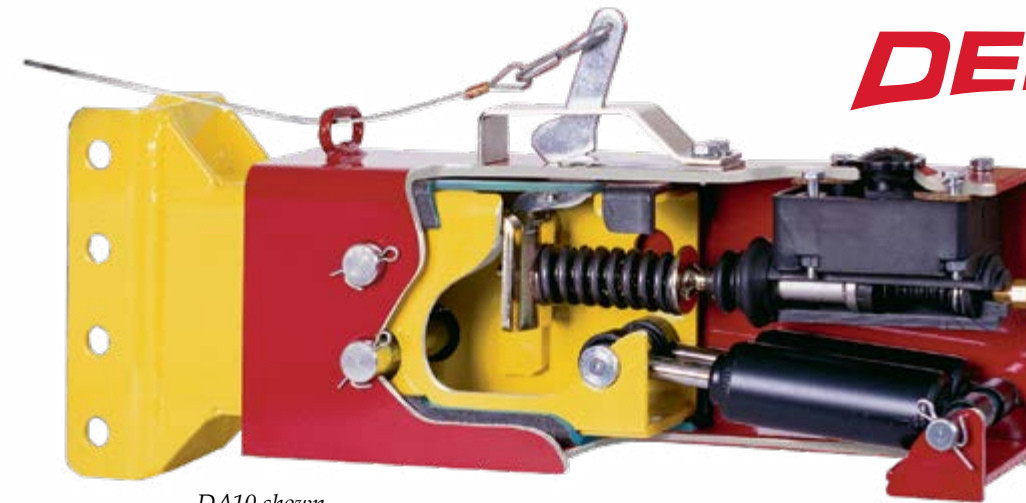

DA10 shown



Hydraulic surge actuator

With industry leading features, Demco Actuators are built heavy duty in the USA for the safest braking and extended trouble-free life.  
**Available in 7000 lb. to 20,000 lb. G.V.W.R. models.**

### FEATURES

- Diaphragm in master cylinder cap provides completely enclosed system
- Raised fill plate prevents intrusion of contaminants when removing cap
- Tie loops on cap allow for tethering, creating a tamper-proof seal
- Bellow boot on push rod for more resistance to moisture and contaminants
- Color-coded decal on emergency lever allows quick glance if brakes are on or off
- Actuators fit standard 3" tongues - 4" is available as an option
- 50° A-frame mounts available
- Acetyl Copolymer liners eliminate reliability issues with rollers
- Line pressure controlled by spring loaded push rod
- Integrated shock dampening design
- Emergency cable is attached with a new clevis for easy replacement in the field
- Finishes include Silver Metallic, Black, Zinc and Primed for corrosion-free operation
- Standard master cylinder (U.S. Patent #6,658,844) on all actuator models are made of long glass reinforced nylon. Rust and corrosion are eliminated.
  - \*Anti-splash baffle deflects the brake fluid "geyser effect" when bleeding system\*
  - \*New composite master cylinder retrofits previous models without modification\*
- DA20 disc brake actuators have an optional 1-1/4" bore aluminum master cylinder and heavy-duty push rod assembly for higher line pressures required for 3 or more axles



Slide Kit



U.S. Patent No. 6,658,844

Composite Master Cylinder



U.S. Patent No. 6,658,844

Aluminum Master Cylinder

## COUPLER CHANNEL AND COUPLER POSITIONS



## OUTER CASE CONFIGURATIONS

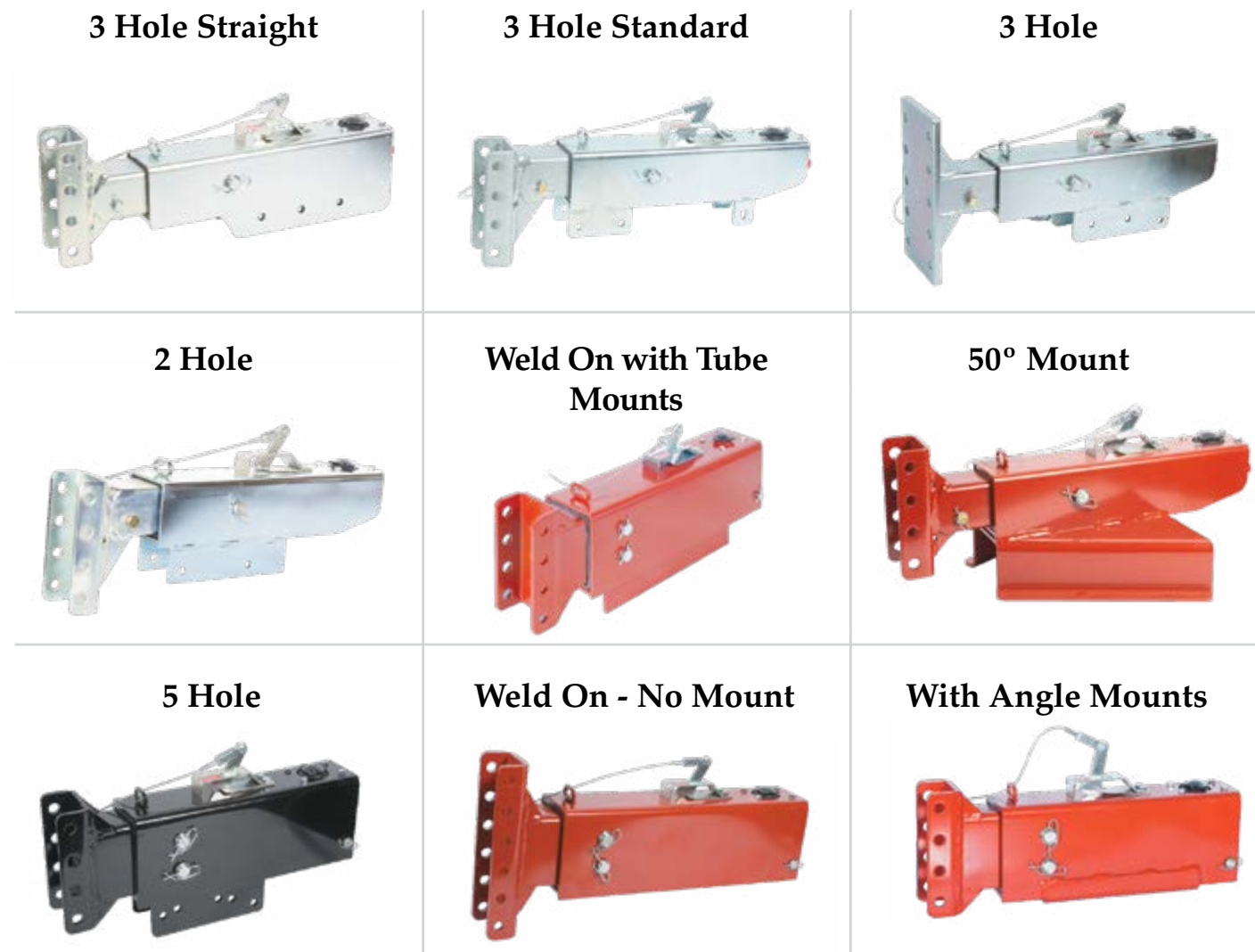

## DEMCO FINISHES



## 3 Hole Standard

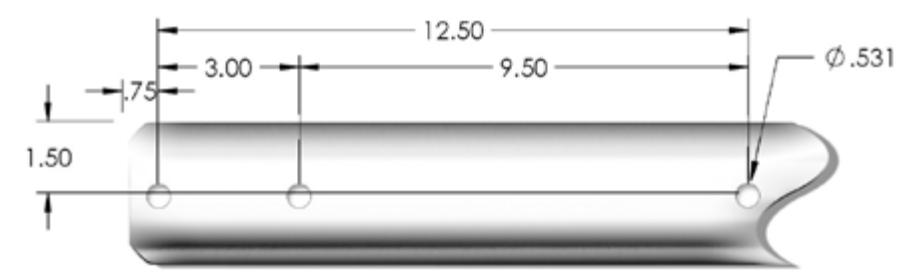

## DA70 Mount

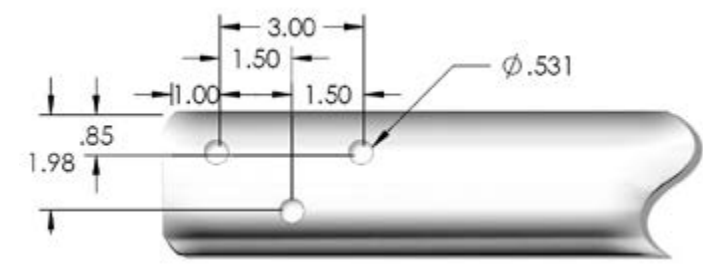

## 2 Hole Standard

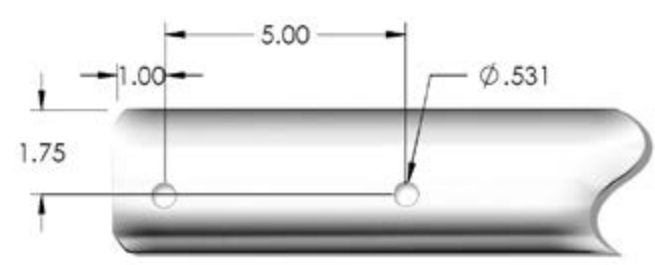

## 5 Hole Standard

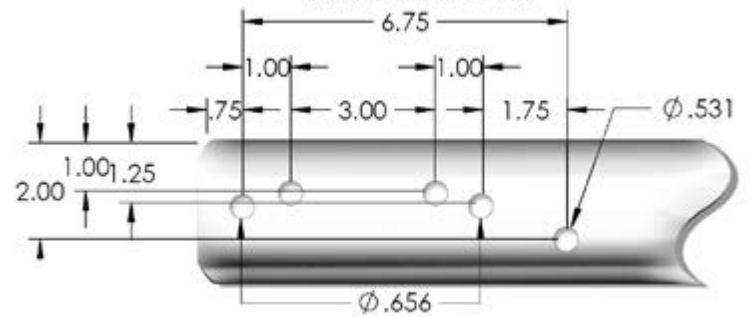

## 3 Hole

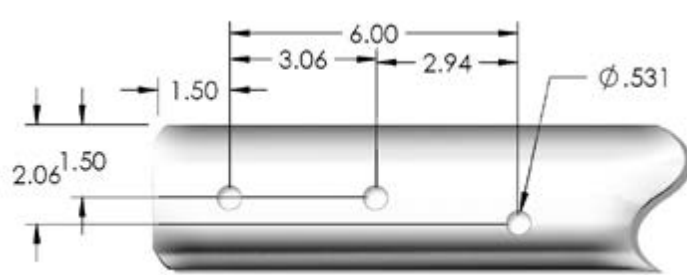

## 3 Hole Straight

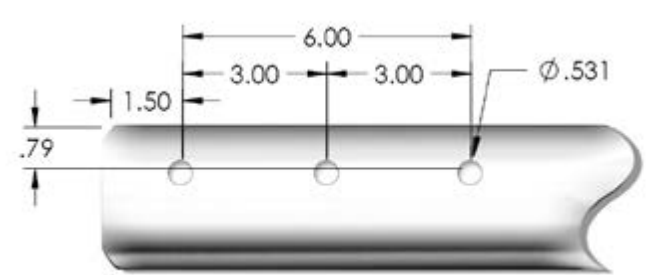

**NEW &  
IMPROVED**

# DEMCO

## DA70 ACTUATORS

### IMPROVEMENTS

Capacity changed from 6000 lbs to 7000 lbs  
EZ Latch Coupler

#### DRUM BRAKE ACTUATOR

DA70

7000 Lb. G.V.W.R.

FINISH: Zinc

Tongue Load: 700 lb., limited to coupler rating

MOUNT: on 3" tongue with 2 1/2" x 4 1/2" grade 5 bolts

- EZ Latch coupler design

ITEM #	TYPE	DESCRIPTION	WT (LBS.)
8705001	DA70	Plated, top mount, EZ Latch coupler	21



#### DISC BRAKE ACTUATOR

DA70

7000 Lb. G.V.W.R.

FINISH: Zinc

Tongue Load: 700 lb., limited to coupler rating

MOUNT: on 3" tongue with 2 1/2" x 4 1/2" grade 5 bolts

- EZ Latch coupler design
- Backup solenoid and cover included

\* Solenoid requires power from back-up lights on tow vehicle

ITEM #	TYPE	DESCRIPTION	WT (LBS.)
8705101	DA70	Plated, top mount, EZ Latch coupler with backup Solenoid	21
8705201	DA70	Plated, top mount, EZ Latch coupler without backup Solenoid	21



## ACTUATORS

**DISC  
BRAKE**

**DA91**

**8000 LB.  
G.V.W.R.**

#### 2" EZ LATCH

ITEM #	POSITION	OUTER CASE	FINISH	NOTES	WT (LBS.)
8669113	Down	3 Hole Standard	Zinc		58



#### 2 5/16" EZ LATCH

ITEM #	POSITION	OUTER CASE	FINISH	NOTES	WT (LBS.)
8758811	Down	3 Hole Standard	Zinc		52
8750311	Down	5 Hole Standard	Zinc	Bypass	54
8758911	Down	5 Hole Standard	Zinc		52



#### 8" 4 BOLT CHANNEL (coupler not included)

ITEM #	POSITION	OUTER CASE	FINISH	NOTES	WT (LBS.)
8758721	Center	3 Hole Standard	Zinc		48
8759422	Center	3 Hole Standard	Primed	Inline Solenoid	49

#### BYPASS SOLENOID KITS FOR DISC BRAKES (fits DA91 and DA10 actuators)

5752	DA91	Solenoid Kit (factory installed)	2
5750	DA91	Solenoid Kit (field installed)	2

#### BLOCKING SOLENOID KIT FOR DISC BRAKES (fits DA91 and DA10 actuators)

5837	DA91	Solenoid Kit (field installed)	2
------	------	--------------------------------	---

Note: Solenoid kit design is subject to change at Demco's discretion.

**DRUM  
BRAKE**

**DA91**

**7000 LB.  
G.V.W.R.**

**DRUM  
BRAKE**

**DA91**

**8000 LB.  
G.V.W.R.**

## 2" SLIDE-LOK

ITEM #	POSITION	OUTER CASE	FINISH	NOTES	WT (LBS.)
8509202	Center	3 Hole Standard	Primed		43
8509602	Center	50° Mount	Primed		62
8509612	Down	50° Mount	Primed		64



8509202



8509612

## 2" EZ LATCH

ITEM #	POSITION	OUTER CASE	FINISH	NOTES	WT (LBS.)
8609502	Center	50° Mount	Primed		59
8609101	Center	3 Hole Standard	Zinc		41
8669112	Down	3 Hole Standard	Zinc		47



8669112

## 2 5/16" SLIDE-LOK

ITEM #	POSITION	OUTER CASE	FINISH	NOTES	WT (LBS.)
8759802	Center	50° Mount	Primed		60
8759812	Down	50° Mount	Primed		62

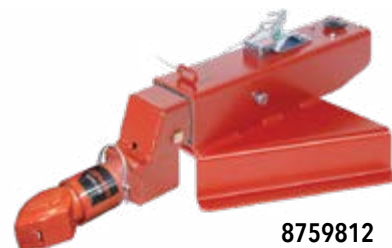

8759812

## 2 5/16" EZ LATCH

ITEM #	POSITION	OUTER CASE	FINISH	NOTES	WT (LBS.)
8759411	Down	3 Hole Standard	Zinc		58



8759411

*Custom mounting available upon request (50 quantity minimum)*

## FLAT PLATE (coupler not included)

ITEM #	POSITION	OUTER CASE	FINISH	NOTES	WT (LBS.)
8759152	Center	3 Hole Standard	Primed		39
8759153	Center	3 Hole	Zinc		40
8759552	Center	50° Mount	Primed		45

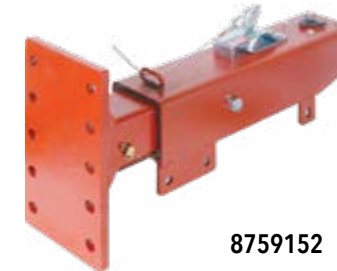

8759152



8759153

## 12" 6 BOLT CHANNEL (coupler not included)

ITEM #	POSITION	OUTER CASE	FINISH	NOTES	WT (LBS.)
8758521	Center	3 Hole Standard	Zinc		38
8759432	Down	Weld On	Primed	.024 Orifice	38



8758521

### DA91 MANUAL LOCKOUT

5939	DA91	Maual Lockout Kit (field installed)	25750
------	------	-------------------------------------	-------

### BYPASS SOLENOID KITS FOR DRUM BRAKES

5751	DA91	Solenoid Kit
------	------	--------------

### DRUM BRAKE CONVERSION

CONVERTS ANY DRUM BRAKE ACTUATOR TO DISC

ITEM #	DESCRIPTION	WT (LBS.)
6116	DA91 Changes standard master cylinder to disc brake with a bypass (factory installed only)	2

8759153

**DRUM  
BRAKE**

**DISC  
BRAKE**

**DA91**

**DA10**

**8000 LB.  
G.V.W.R.**

**12,500 LB.  
G.V.W.R.**

**8" 4 BOLT CHANNEL** (coupler not included)

ITEM #	POSITION	OUTER CASE	FINISH	NOTES	WT (LBS.)
8759231	Down	2 Hole	Zinc		52
8759241	Up	2 Hole	Zinc		52
8760011	Center	3 Hole Straight	Zinc	Lock Out	37
8760012	Center	3 Hole Straight	Silver	Lock Out	37
8759522	Center	50° Mount	Primed		45
8759532	Down	50° Mount	Primed		45
8759922	Center	Weld On	Primed		30
8759933	Down	Weld On	Primed	Lock Out	31
8759942	Up	Weld On	Primed		30
8759121	Center	3 Hole Standard	Zinc		32
8759122	Center	3 Hole Standard	Primed		32
8759122-30	Center	3 Hole Standard	Black		32
8759131	Down	3 Hole Standard	Zinc		32
8759132	Down	3 Hole Standard	Primed		32
8759138	Down	3 Hole Standard	Black		32
8759142	Up	3 Hole Standard	Primed		32

**2 5/16" EZ LATCH**

ITEM #	POSITION	OUTER CASE	FINISH	NOTES	WT (LBS.)
8104002	Center	Weld on	Primed	Bypass	49
8104311	Down	5 Bolt Universal	Zinc	Bypass	53
8104411	Down	5 Bolt Universal	Zinc		53



8104311



8104411

**8" 4 BOLT CHANNEL** (coupler not included)

ITEM #	POSITION	OUTER CASE	FINISH	NOTES	WT (LBS.)
8103721	Center	5 Hole Standard	Zinc		52
8105422	Center	50° Mount	Primed		52

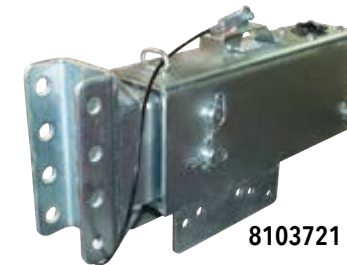

8103721

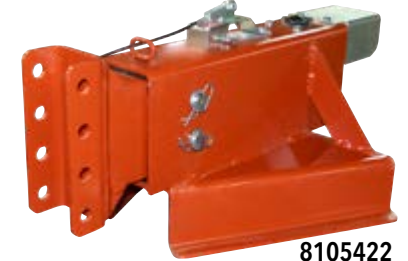

8105422

**FLAT PLATE** (coupler not included)

ITEM #	POSITION	OUTER CASE	FINISH	WT (LBS.)
8101152	Center	Weld On	Primed	60
8101952	Center	Weld On Angle Mounts	Primed	58

**BYPASS SOLENOID KITS FOR DRUM BRAKES**

5752	DA10	Solenoid Kit
------	------	--------------

Custom mounting available upon request (50 quantity minimum)

**DRUM  
BRAKE**

**DA10**

**12,500 LB.  
G.V.W.R.**

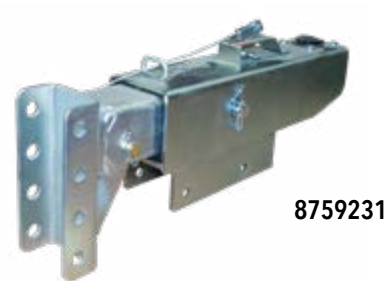

8759231



8759522

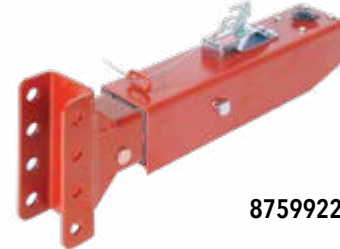

8759922



8759933

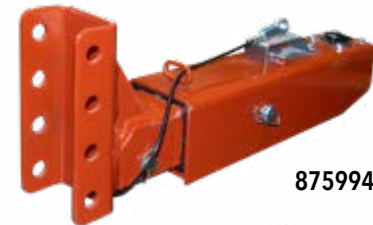

8759942



8759121

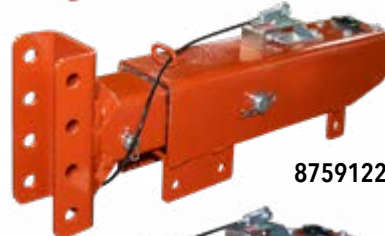

8759122



8759122-30

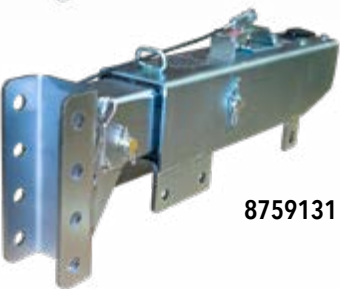

8759131



8759132



8759138

**DRUM  
BRAKE**

**DRUM  
BRAKE**

**DA10**

**DA10**

**12,500 LB.  
G.V.W.R.**

**12,500 LB.  
G.V.W.R.**

### 2 5/16" EZ LATCH

### DISC BRAKE CONVERSION

CONVERTS ANY DRUM BRAKE ACTUATOR TO DISC

ITEM #	POSITION	OUTER CASE	FINISH	NOTES	WT (LBS.)
8101801	Center	5 Hole Standard	Zinc		55
8101802	Center	5 Hole Standard	Primed		56
8102511	Down	5 Hole Standard	Zinc		54
8103102	Center	Weld On	Primed		49

ITEM #	DESCRIPTION	WT (LBS.)
6114	Changes standard master cylinder to large bore disc brake with a bypass. Installation includes replacement push rod (factory installed only)	2



8101801



8102511



8103102

### 12" 6 BOLT CHANNEL (coupler not included)

### 8" 4 BOLT CHANNEL (coupler not included)

ITEM #	POSITION	OUTER CASE	FINISH	NOTES	WT (LBS.)
8102131	Down	5 Hole Standard	Zinc		55
8101532	Down	3 Hole Standard	Primed		54
8101541	Down	3 Hole Standard	Zinc	.031 orifice	50
8101522	Center	Weld On	Primed		53
8101523	Center	Weld On	Black		53
8103432	Down	Weld On	Primed		53

ITEM #	POSITION	OUTER CASE	FINISH	NOTES	WT (LBS.)
8101021	Center	5 Hole Standard	Zinc		52
8101022	Center	5 Hole Standard	Primed		52
8101023	Center	5 Hole Standard	Black		52
8101031	Down	5 Hole Standard	Zinc		52
8101038	Down	5 Hole Standard	Black		52
8101042	Up	5 Hole Standard	Primed		52
8104821	Center	3 Hole Standard	Zinc		49
8104831	Down	3 Hole Standard	Zinc		49
8102222	Center	50° Mount	Primed		62
8102232	Down	50° Mount	Primed		62
8100122	Center	Angle Mount	Primed		50
8101222	Center	Weld On	Primed		50
8101232	Down	Weld On	Primed		50

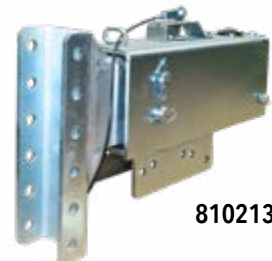

8102131



8101532



8101541

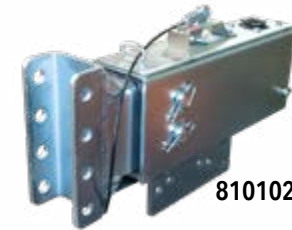

8101021

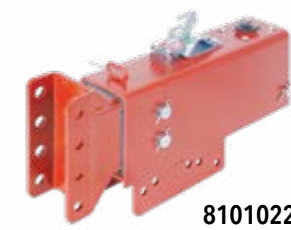

8101022



8101031



8101522



8101523



8103432



8101038



8101023



8104821



8101042



8102222



8102232



8101222

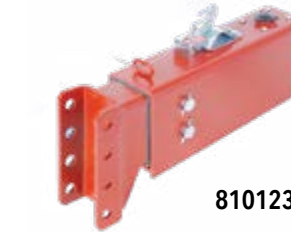

8101232



8100122

**DISC  
BRAKE**

**DA16**

**16,000 LB.  
G.V.W.R.**

**2 5/16" EZ LATCH**

ITEM #	POSITION	OUTER CASE	FINISH	NOTES	WT (LBS.)
8164311	Down	5 Hole	Zinc	Bypass	87



**DISC  
BRAKE**

**DA20**

**20,000 LB.  
G.V.W.R.**

**2 5/16" EZ LATCH**

ITEM #	POSITION	OUTER CASE	FINISH	NOTES	WT (LBS.)
8203102	Center	Weld On Tube Mount	Primed		70
8204311	Down	5 Hole	Zinc	Bypass	71
8204702	Center	Weld On	Primed	Bypass	70

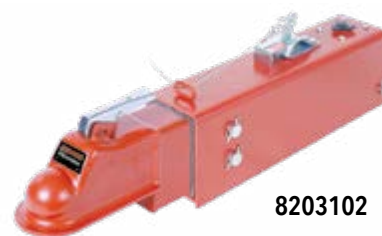

**8" 4 BOLT CHANNEL (coupler not included)**

ITEM #	POSITION	OUTER CASE	FINISH	NOTES	WT (LBS.)
8205222	Center	50° Mount	Primed	Bypass	80
8205322	Center	50° Mount	Primed	Inline	80

**2 5/16" EZ LATCH**

ITEM #	POSITION	OUTER CASE	FINISH	NOTES	WT (LBS.)
8204011	Down	5 Hole	Zinc		70



**8" 4 BOLT CHANNEL (coupler not included)**

ITEM #	POSITION	OUTER CASE	FINISH	NOTES	WT (LBS.)
8202022	Center	Weld On	Primed		59
8202023	Center	Weld On	Black		59
8202031	Center	5 Hole	Plated		59
8202032	Down	Weld On	Primed		59
8202042	Up	Weld On	Primed		59
8202122	Center	Weld On Tube Mount	Primed		70
8202132	Down	Weld On Tube Mount	Primed		70
8202222	Center	50° Mount	Primed		80
8202232	Down	50° Mount	Primed		80

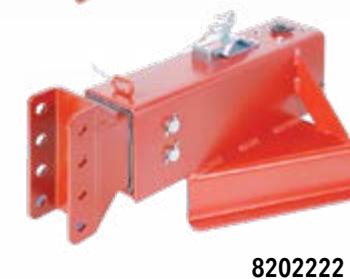
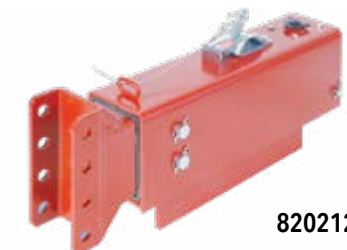
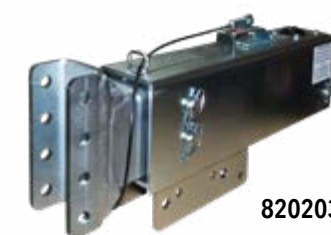

**DRUM  
BRAKE**

**DA20**

**20,000 LB.  
G.V.W.R.**

**BYPASS SOLENOID KITS FOR DRUM BRAKES**

5755	DA20	Solenoid Kit
------	------	--------------



**DRUM  
BRAKE**

**DA20**

**20,000 LB.  
G.V.W.R.**

**FLAT PLATE** (coupler not included)

ITEM #	POSITION	OUTER CASE	FINISH	NOTES	WT (LBS.)
8202052	Center	Weld On	Primed		62
8202152	Center	Weld On Tube Mount	Primed		70



8202052

**NO CHANNEL SLIDER** (coupler not included)

ITEM #	POSITION	OUTER CASE	FINISH	NOTES	WT (LBS.)
8202932	Bare	Weld On	Primed		69



8202932

**12" 6 BOLT CHANNEL** (coupler not included)

ITEM #	POSITION	OUTER CASE	FINISH	NOTES	WT (LBS.)
8202521	Center	3 Hole Standard	Zinc		72
8202522	Center	3 Hole Standard	Primed		72
8202531	Down	3 Hole Standard	Zinc		72
8202532	Down	3 Hole Standard	Primed		72
8203322	Center	Weld On	Primed		62
8203332	Down	Weld On	Primed		62
8204333	Down	5 Hole	Black		72

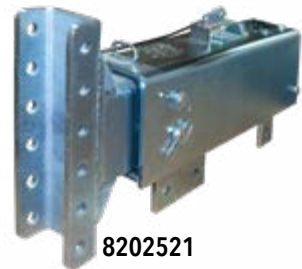

8202521

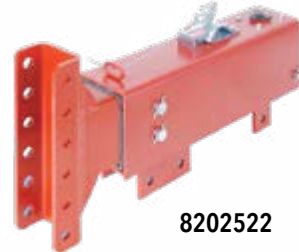

8202522



8203332



8204333

**DISC BRAKE CONVERSION**

CONVERTS ANY DRUM BRAKE ACTUATOR TO DISC

ITEM #	DESCRIPTION	WT (LBS.)
6115	DA20 Changes standard master cylinder to large bore disc brake with a bypass. Installation includes replacement push rod (factory installed only)	2

**UNASSEMBLED ACTUATOR KITS** DA91, DA10, and DA20

These actuators come unprimed and are unassembled for weld on applications. Parts come boxed for assembly after welding and paint.

ITEM #	POSITION	OUTER CASE	FINISH	NOTES	SAME AS	WT (LBS.)
6106	8" Center	Weld On	None	DA91 Knocked Down	8759922	37
6050	8" Center	Weld On	None	DA10 Knocked Down	8101222	47
5930	12" Center	Weld On	None	DA10 Knocked Down	8101522	50
6049	8" Center	Weld On	None	DA20 Knocked Down	8202032	56
6086	12" Center	Weld On	None	DA20 Knocked Down	8203322	60
5947	12" Down	Weld On	None	DA20 Knocked Down	8203332	60
5541	Bare	Weld On	None	DA20 Knocked Down	8202932	50
6171	8" Up	Weld On	None	DA91 Knocked Down	8759942	30
6185	8" Up	Weld On	None	DA10 Knocked Down	8101042	30
6186	Flat Plate	Weld On	None	DA20 Knocked Down	8202052	62



**ACTUATOR REPLACEMENT COMPONENTS** FOR DISC AND DRUM BRAKES

**Brake Master Cylinder**  
(Drum) 5650  
(Disc) 5672



**Brake Master Cylinder With Inline Solenoid**  
(Drum) 5921  
(Disc) 5919



**Brake Master Cylinder With Bypass Solenoid**  
(Drum) 5920  
(Disc) 5918



**Large Bore Aluminum Disc Brake Master Cylinder with Bypass Solenoid**  
(Disc) 6113



**Large Bore Aluminum Disc Brake Master Cylinder with Inline Solenoid**  
(Disc) 6379



**Replacement Inline Solenoid**  
11993



**Replacement Bypass Solenoid**  
(Bypass Solenoid) 05561  
(Bypass Solenoid Kit) 5404



**DEMCO**

**EZ LATCH COUPLER**



STEP 1



The EZ Latch coupler remains in its locked position. No need to open the coupler. Simply back under the coupler and start lowering it onto the ball.

STEP 2



The coupler will automatically open to accept the hitch ball into the coupler socket.

STEP 3



Once the trailer is completely lowered, the coupler will automatically lock around the hitch ball.

Demco's exclusive EZ Latch coupler design automatically latches when dropped onto a hitch ball.

- **SAFETY** - All Demco EZ Latch couplers exceed all required SAE J684 safety standards without the use of a safety pin.
- **SECURITY** - Never forget to latch your coupler again. Let our EZ Latch system bring you peace of mind when hooking up your next trailer.
- **MAINTENANCE FRIENDLY** - The EZ Latch System is a maintenance-free system. NO grease or adjustments needed.
- **VARIETY** - EZ Latch couplers are available in a variety of styles and weight ratings: channel mount, tube mount, and A-frame from 10,000 to 21,000 lb. G.V.W.R.
- **LIFETIME WARRANTY** - Limited Lifetime Warranty on the composite handle to the original owner

The EZ Latch coupler is offered in an array of different hitch mounts in both 2" and 2 5/16" ball coupler sizes

**MOUNTING CONFIGURATIONS INCLUDE:**

- Weld on or bolt on 3" tongue tube
- Weld on or bolt on A-frame
- Bolt-on adjustable height channel mounts

**See how the EZ Latch coupler works:**



Scan the QR code using your phone's camera or click on square

Demco 2" and 2 5/16" EZ Latch Couplers are Patent #76906732

**2" & 2 5/16" Tube Mount**

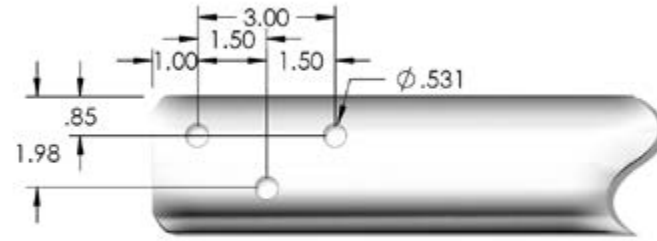

**2" & 2 5/16" 50° A-Frame Mount**

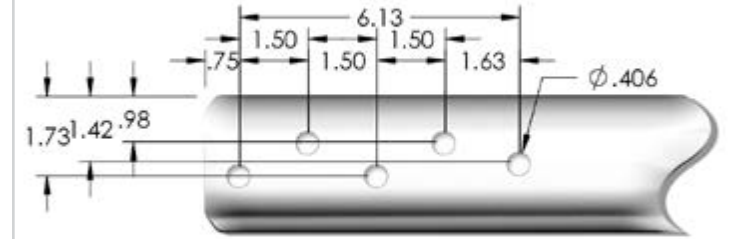

**2" & 2 5/16" Tube Mount**

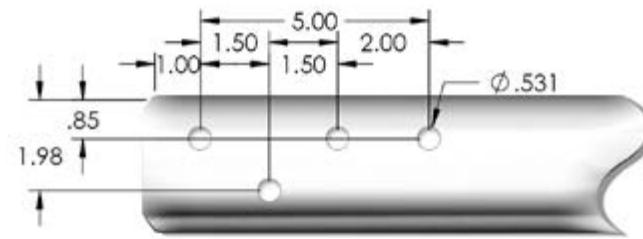

**2" & 2 5/16" Tube Mount**

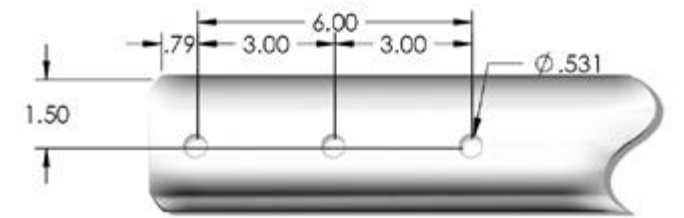

**Flat Mount**

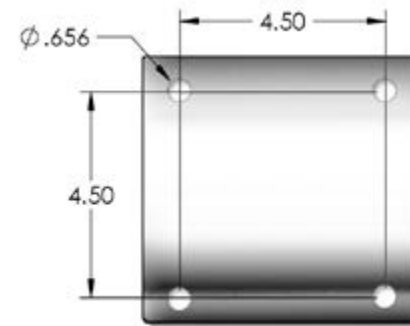

**Channel Mount**

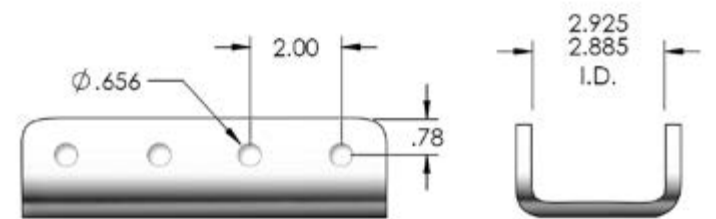

**Trimax Adjustable Coupler Lock**



7/8", 2-1/2" to 3-1/2" Spans  
• Triple Plated Chrome Finish

**DEMCO FINISHES**



Silver: -52  
Powder coated

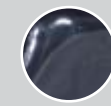

Black: -81  
Powder coated



Zinc: -95  
Plated zinc



Primed: -97  
Powder coated

# 2" COUPLERS

# 2" COUPLERS

6000 LB.  
G.V.W.R.

## CHANNEL MOUNT

ITEM #	FINISH	DESCRIPTION	WT (LBS.)
12113-95	Zinc	Lever lock, bolt on channel	7



7000 LB.  
G.V.W.R.

## CHANNEL MOUNT

ITEM #	FINISH	DESCRIPTION	WT (LBS.)
05823-81	Black	Slide-lok, bolt on channel	12
05823-95	Zinc	Slide-lok, bolt on channel	12
05823-97	Primed	Slide-lok, bolt on channel	12



7000 LB.  
G.V.W.R.

## TUBE MOUNT

ITEM #	FINISH	DESCRIPTION	WT (LBS.)
15945	Zinc	EZ Latch composite handle, 3 hole bolt on	8



10000 LB.  
G.V.W.R.

## TUBE MOUNT

ITEM #	FINISH	DESCRIPTION	WT (LBS.)
15629-52	Silver	EZ Latch composite handle, weld on	8
15629-97	Primed	EZ Latch composite handle, weld on	8
12563	Primed	EZ Latch metal handle, weld on	8
12564	Zinc	EZ Latch metal handle, 3 hole bolt on	8
15000-52	Silver	EZ Latch composite handle, 4 hole bolt on	8
15000-95	Zinc	EZ Latch composite handle, 4 hole bolt on	8



NOTE: All Demco 2" EZ Latch Couplers are Patent #76906732.

## TUBE MOUNT

ITEM #	FINISH	DESCRIPTION	WT (LBS.)
12717	Zinc	EZ Latch metal handle, 4 hole bolt on	7
12925	Zinc	EZ Latch metal handle, 3 hole bolt on, short body	7
13689-52	Silver	EZ Latch composite handle, 3 hole bolt on, short body	7
13689-95	Zinc	EZ Latch composite handle, 3 hole bolt on, short body	7



## CHANNEL MOUNT

ITEM #	FINISH	DESCRIPTION	WT (LBS.)
12688-81	Black	EZ Latch metal handle, 4 bolt on	9
12688-95	Zinc	EZ Latch metal handle, 4 bolt on	9
14976-52	Silver	EZ Latch composite handle, 4 bolt on	9
14976-81	Black	EZ Latch composite handle, 4 bolt on	9
14976-95	Zinc	EZ Latch composite handle, 4 bolt on	9
14976-97	Primed	EZ Latch composite handle, 4 bolt on	9
16825-52	Silver	EZ Latch composite handle, 2 bolt on	12
16825-81	Black	EZ Latch composite handle, 2 bolt on	12
16825-95	Zinc	EZ Latch composite handle, 2 bolt on	12
16825-97	Primed	EZ Latch composite handle, 2 bolt on	12



6378	Hardware Kit for 16825 (contains 2 GR8 5/8" bolts, 2 washers, 2 lock nuts)	2
6166	Channel Mount Coupler Hardware Kit (contains 4 GR5 5/8" bolts, 4 washers, 4 lock nuts)	2

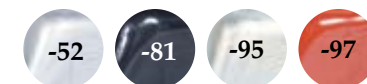

10,000 LB.  
G.V.W.R.

# 2" COUPLERS

# 2 5/16" COUPLERS

10,000 LB.  
G.V.W.R.

21,000 LB.  
G.V.W.R.

## FLAT MOUNT

ITEM #	FINISH	DESCRIPTION	WT (LBS.)
15080-81	Black	EZ Latch composite handle, 5/8" holes	13.5
15080-97	Primed	EZ Latch composite handle, 5/8" holes	13.5



15080-81

## 50° MOUNT

ITEM #	FINISH	DESCRIPTION	WT (LBS.)
15650-52	Silver	EZ Latch Composite, 5 hole bolt on	20
16698	Raw	Cast A-frame, weld on	20
16698-81	Black	Cast A-frame, weld on	20
16854-81	Black	Cast A-frame with chain anchor	20
16854-95	Zinc	Cast A-frame with chain anchor	20
16908	Raw	Cast A-frame bolt on channel	20
16908-52	Silver	Cast A-frame bolt on channel	20
16908-81	Black	Cast A-frame bolt on channel	20
16908-95	Zinc	Cast A-frame bolt on channel	20
16908-97	Primed	Cast A-frame bolt on channel	20
17115	Raw	A-frame bolt on channel without jack hole	20
17115-95	Zinc	A-frame bolt on channel without jack hole	20
17115-81	Black	A-frame bolt on channel without jack hole	20



16698-81



16854-81



17115

## 2" COUPLER REPAIR KITS

ITEM #	DESCRIPTION	WT (LBS.)
5696	Lever lock coupler repair kit 6000 lb. non EZ Latch	2
5876	EZ Latch coupler repair kit 10,000 lb. metal handle	2
6109	EZ Latch coupler repair kit 10,000 lb. composite handle	2
6317	Composite handle only	1



5696



5876



6109



6317

6166	Channel Mount Coupler Hardware Kit (contains 4 GR5 5/8 bolts, 4 washers, 4 lock nuts)	2
------	---	---

## TUBE MOUNT

ITEM #	FINISH	DESCRIPTION	WT (LBS.)
12662-97	Primed	EZ Latch metal handle, weld on short body	8.5
15931-52	Silver	EZ Latch composite handle, bolt on channel	17
15931-81	Black	EZ Latch composite handle, bolt on channel	17
15931-95	Zinc	EZ Latch composite handle, bolt on channel	17
16080-52	Silver	EZ Latch composite handle, 5 bolt on channel	19
16080-81	Black	EZ Latch composite handle, 5 bolt on channel	19
16080-95	Zinc	EZ Latch composite handle, 5 bolt on channel	19



12662-97



15931-95



16080-95

## FLAT MOUNT

ITEM #	FINISH	DESCRIPTION	WT (LBS.)
15923-81	Black	EZ Latch composite handle, flat mount 5/8" holes	13.5
15923-95	Zinc	EZ Latch composite handle, flat mount 5/8" holes	13.5
15923-97	Primed	EZ Latch composite handle, flat mount 5/8" holes	13.5
16759-81	Black	EZ Latch composite handle, flat mount 3/4" holes	13.5
16759-95	Zinc	EZ Latch composite handle, flat mount 3/4" holes	13.5
16759-97	Primed	EZ Latch composite handle, flat mount 3/4" holes	13.5



15923-81



16759-81

## 50° MOUNT - WELD ON

ITEM #	FINISH	DESCRIPTION	WT (LBS.)
12660-97	Primed	EZ Latch composite handle, A-frame weld on with jack hole	12
15337-97	Primed	EZ Latch metal handle, A-frame weld on with jack hole	12
17063	Raw	EZ Latch composite handle, A-frame weld on with jack hole	12
17063-81	Primed	EZ Latch composite handle, A-frame weld on with jack hole	12
17063-97	Primed	EZ Latch composite handle, A-frame weld on with jack hole	12



12660-97



15337-97



17063

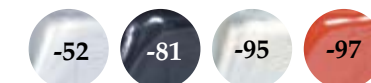

**21,000 LB.  
G.V.W.R.**

### 32° / 50° MOUNT - BOLT ON

ITEM #	FINISH	DESCRIPTION	WT (LBS.)
16680-52	Silver	50°, EZ Latch composite handle, A-frame bolt on with jack hole and chain anchors	17
16680-95	Zinc	50°, EZ Latch composite handle, A-frame weld on with jack hole and chain anchors	17
15633-52	Silver	32°, EZ Latch composite handle, A-frame weld on with jack hole	17
15633-81	Black	32°, EZ Latch composite handle, A-frame weld on with jack hole	17
15633-97	Zinc	32°, EZ Latch composite handle, A-frame weld on with jack hole	17
17106	Raw	50°, EZ Latch composite handle, A-frame bolt on with jack hole	17
17106-81	Black	50°, EZ Latch composite handle, A-frame bolt on with jack hole	17
17106-95	Zinc	50°, EZ Latch composite handle, A-frame bolt on with jack hole	17
17106-97	Primed	50°, EZ Latch composite handle, A-frame bolt on with jack hole	17



### CHANNEL MOUNT CAST COUPLER

ITEM #	FINISH	DESCRIPTION	WT (LBS.)
14040-52	Silver	EZ Latch composite handle, bolt on	9
14040-81	Black	EZ Latch composite handle, bolt on	9
14040-95	Zinc	EZ Latch composite handle, bolt on	9
14040-97	Primed	EZ Latch composite handle, bolt on	9
15791-52	Silver	EZ Latch metal handle, bolt on	9
15791-81	Black	EZ Latch metal handle, bolt on	9
15791-95	Zinc	EZ Latch metal handle, bolt on	9
15791-97	Primed	EZ Latch metal handle, bolt on	9



### 15791 CAST COUPLER WITH CHANNEL

ITEM #	DESCRIPTION	WT (LBS.)
6178-81	2 5/16" EZ Latch, channel mount 12" 6 hole	18
6178-97	2 5/16" EZ Latch, channel mount 12" 6 hole	18
6184-81	2 5/16" EZ Latch, channel mount 8" 4 hole	16
6315-81	2 5/16" EZ Latch, channel mount 12" 6 hole w/hardware	19



ITEM #	DESCRIPTION	WT (LBS.)
6166	Channel Mount Coupler Hardware Kit (contains 4 GR5 5/8" bolts, 4 washers, 4 lock nuts)	2

### TUBE MOUNT

ITEM #	FINISH	DESCRIPTION	WT (LBS.)
13203-52	Silver	EZ Latch composite handle, bolt on channel	11
13203-95	Zinc	EZ Latch composite handle, bolt on channel	11



### CHANNEL MOUNT

ITEM #	DESCRIPTION	WT (LBS.)
05557-95	2 5/16" Slide-lok, 12,500 lb. G.V.W.R. capacity, bolt on channel	12
05557-81	2 5/16" Slide-lok, 12,500 lb. G.V.W.R. capacity, bolt on channel	12



### 50° MOUNT - WELD ON

ITEM #	FINISH	DESCRIPTION	WT (LBS.)
16637-81	Black	EZ Latch composite handle, A-frame weld on with jack hole	12
16637-95	Zinc	EZ Latch composite handle, A-frame weld on with jack hole	12
16637-97	Primed	EZ Latch composite handle, A-frame weld on with jack hole	12
16637	Raw	EZ Latch composite handle, A-frame weld on with jack hole	12



### 2 5/16" COUPLER REPAIR KITS

ITEM #	DESCRIPTION	WT (LBS.)
5817	EZ Latch coupler repair kit metal handle	2
6008	EZ Latch coupler repair kit composite handle	2
6288	EZ Latch coupler repair kit for cast coupler	2



**18,000 LB.  
G.V.W.R.**

**12,500 LB.  
G.V.W.R.**

20,000 LB.  
G.V.W.R.

## 2 5/16" COMBO COUPLERS AND CHANNELS

### 14040 COUPLER CHANNELS

ITEM #	FINISH	DESCRIPTION	WT (LBS.)
6124-52	Silver	EZ Latch, channel mount 12" 6 hole .375" channel without bolts	18
6124-81	Black	EZ Latch, channel mount 12" 6 hole .375" channel without bolts	18
6124-95	Zinc	EZ Latch, channel mount 12" 6 hole .375" channel without bolts	18
6124-97	Primed	EZ Latch, channel mount 12" 6 hole .375" channel without bolts	18
6167-81	Black	EZ Latch, channel mount 8" 4 hole without bolts	18
6167-97	Primed	EZ Latch, channel mount 8" 4 hole without bolts	18



21,000 LB.  
G.V.W.R.

### 14040 COUPLER CHANNELS

ITEM #	FINISH	DESCRIPTION	WT (LBS.)
6125-52	Silver	EZ Latch, channel mount 12" 6 hole .5" channel with bolts and gussets	21
6125-81	Black	EZ Latch, channel mount 12" 6 hole .5" channel with bolts and gussets	21
6125-95	Zinc	EZ Latch, channel mount 12" 6 hole .5" channel with bolts and gussets	21
6125-97	Primed	EZ Latch, channel mount 12" 6 hole .5" channel with bolts and gussets	21



25,000 LB.  
G.V.W.R.

## PINTLE RING

### PINTLE RING CHANNEL MOUNT

ITEM #	FINISH	DESCRIPTION	WT
09557-52	Silver	3" ID, 6" OD, 25,000 lb. bolt on channel	12
09557-81	Black	3" ID, 6" OD, 25,000 lb. bolt on channel	12
09557-95	Zinc	3" ID, 6" OD, 25,000 lb. bolt on channel	12
09557-97	Primed	3" ID, 6" OD, 25,000 lb. bolt on channel	12
6135-52	Silver	3" ID, 6" OD, bolt on channel with 12" 20,000 lb. channel and hardware	12
6135-81	Black	3" ID, 6" OD, bolt on channel with 12" 20,000 lb. channel and hardware	12
6135-95	Zinc	3" ID, 6" OD, bolt on channel with 12" 20,000 lb. channel and hardware	12
6135-97	Primed	3" ID, 6" OD, bolt on channel with 12" 20,000 lb. channel and hardware	12

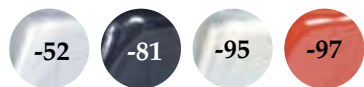

## CHANNEL MOUNTS

ITEM #	FINISH	DESCRIPTION	
15795-52	Silver	A-frame channel mount bolt on with jack hole	
15349-52	Silver	A-frame channel mount bolt on without jack hole	20
13867-52	Silver	3" tube channel mount bolt on 12,000 lb. G.V.W.R. capacity	16
13867-81	Black	3" tube channel mount bolt on 12,000 lb. G.V.W.R. capacity	16
13867-95	Zinc	3" tube channel mount bolt on 12,000 lb. G.V.W.R. capacity	16
13867-97	Primed	3" tube channel mount bolt on 12,000 lb. G.V.W.R. capacity	16
15974-52	Silver	A-frame channel mount without jack hole channel down, 14,000 lb. G.V.W.R. capacity	20



12,000 LB.  
AND  
14,000 LB.  
G.V.W.R.

## CLEVIS CHANNEL MOUNT

ITEM #	FINISH	DESCRIPTION	
05593-81	Black	Clevis, 10,000 lb. G.V.W.R. capacity, bolt on channel	11
05593-95	Zinc	Clevis, 10,000 lb. G.V.W.R. capacity, bolt on channel	11
05593-97	Primed	Clevis, 10,000 lb. G.V.W.R. capacity, bolt on channel	11
12676-81	Black	Clevis, 20,000 lb. G.V.W.R. capacity, bolt on channel	12
12676-95	Zinc	Clevis, 20,000 lb. G.V.W.R. capacity, bolt on channel	12



10,000 LB.  
AND  
20,000 LB.  
G.V.W.R.

## CHANNELS

### WELD-ON CHANNEL BRACKETS 8"

4 Hole (Hole spacing 2" centers) 8" over-all length.

ITEM #	WT (LBS.)	MIN-MAX ID	CHANNEL THICKNESS	WEIGHT RATING	WT (LBS.)
55342	2.885"-2.925"	.25"		7,500 lbs.	4
55289	2.885"-2.925"	.313"		12,500 lbs.	5
57362	2.885"-2.925"	.375"		20,000 lbs.	5
66736	2.885"-2.925"	.5" Grade 80		21,000 lbs.	5



7500 LB.  
AND  
21,000 LB.  
G.V.W.R.

### WELD-ON CHANNEL BRACKETS 12"

6 Hole (Hole spacing 2" centers) 12" over-all length.

ITEM #	WT (LBS.)	MIN-MAX ID	CHANNEL THICKNESS	WEIGHT RATING	WT (LBS.)
59601	2.885"-2.925"	.313"		12,500 lbs.	7
59602	2.885"-2.925"	.375"		20,000 lbs.	8
66134	2.885"-2.925"	.5"		21,000 lbs.	9



## TONGUES FOR AGRICULTURAL RUNNING GEARS OR DROP TONGUE TRAILERS

### 12 TON G.V.W.R. BOLT-ON

ITEM #	TYPE	DESCRIPTION	WT (LBS.)
07686	DA12	Painted black, agricultural gear actuator	23



### 13 TON G.V.W.R.

Telescoping tongues - 77.5" overall length, 17.75" telescope

ITEM #	TYPE	DESCRIPTION	WT (LBS.)
5976	Tongue	Raw tongue assembly without brakes, 2 bolt center channel, no mounts	89
5967	Tongue	Raw tongue assembly with brakes, 2 bolt center channel, no mounts	93
6173	Tongue	Raw Tongue assembly with brakes, clevis no mounts	109



### 24 TON G.V.W.R. A-FRAME

Telescoping A-Frame tongues - 86" overall length, 17.75" Telescope 2" mounting tabs needed 31.25" on center.

ITEM #	TYPE	DESCRIPTION	WT (LBS.)
6133-81	A-Frame	Tongue Gloss Black Assembled with Brakes, Clevis, A-Frame	260
6133-71	A-Frame	Tongue Gloss Red Assembled with Brakes, Clevis, A-Frame	260
6134-81	A-Frame	Tongue Gloss Black Assembled without Brakes, Clevis, A-Frame	235
6134-71	A-Frame	Tongue Gloss Red Assembled without Brakes, Clevis, A-Frame	235



### 24 TON G.V.W.R.

Telescoping tongues - 77.5" overall length 17.75 telescope.

ITEM #	TYPE	DESCRIPTION	WT (LBS.)
5730	Tongue	Raw tongue assembly without brakes, clevis, no mounts	143
6030	Tongue	Raw tongue unassembled without brakes, clevis, no mounts	143
5597	Tongue	Raw tongue assembly with brakes, clevis, no mounts	165
6029	Tongue	Raw tongue unassembled with brakes, clevis, no mounts	167
6182	Tongue	Raw tongue assembly with manual lock-out brakes, clevis, no mounts	165
6181	Tongue	Raw tongue unassembled with manual lock-out brakes, clevis, no mounts	167



### FREE BACKING BRAKES

Incorporates a "fall-away" shoe which diminishes shoe drag when backing up. Requires periodic manual adjustment. Marine cluster has galvanized back plate, stainless steel spring hardware, plated wheel cylinder and riveted marine brake shoe.

PRODUCT	RIGHT#	LEFT#	BOLT HOLE PATTERN	WT (LBS.)
Marine	SB40715M	SB40716M	4" on 4"	10

PRODUCT	TYPE	DESCRIPTION
Shoe Kit	07812	2 Front - 2 Rear

### 10" Free Backing Brakes



Reverse Braking - Minimal  
Axle Rating - 3500 lbs.  
Wheel Size - 13 - 15"

### UNI-SERVO BRAKES

20% braking in reverse. Requires periodic manual adjusting. Marine cluster has galvanized back plate, stainless steel spring hardware, plated wheel cylinder and riveted marine brake shoe.

PRODUCT	RIGHT#	LEFT#	BOLT HOLE PATTERN	WT (LBS.)
Marine	SB18787M	SB18788M	4" on 4"	10

PRODUCT	TYPE	DESCRIPTION
Shoe Kit	07811	2 Front - 2 Rear

### 10" Uni-Servo Brakes



Reverse Braking - 15 - 20%  
Axle Rating - 3500 lbs.  
Wheel Size - 13 - 15"

### DUO-SERVO BRAKES

Applies braking pressure equally in forward or reverse travel. Primarily for industrial applications. Requires periodic manual adjustment. Marine cluster has galvanized back plate, stainless steel spring hardware, plated wheel cylinder and riveted marine brake shoe.

PRODUCT	RIGHT#	LEFT#	BOLT HOLE PATTERN	WT (LBS.)
Marine	SB18793M	SB18794M	4" on 4"	9.2

PRODUCT	TYPE	DESCRIPTION
Shoe Kit	07811	2 Front - 2 Rear

### 10" Duo-Servo Brakes



Reverse Braking - 100%  
Axle Rating - 3500 lbs.  
Wheel Size - 13 - 15"

# 12" HYDRAULIC BRAKE ASSEMBLIES

## FREE BACKING BRAKES

Reverse braking - minimal. Axle rating - 5,200 lb. Wheel size - 14.5" - 16"  
Marine cluster has galvanized back plate, stainless steel spring hardware, plated wheel cylinder and riveted marine brake shoe.

PRODUCT	RIGHT#	LEFT#	BOLT HOLE PATTERN	WT (LBS.)
Marine	SB42028M	SB42029M	5 on 3.875"	19

PRODUCT	TYPE	DESCRIPTION
Shoe Kit	07814	2 Front - 2 Rear

12" Free Backing



12" Uni-Servo



## UNI-SERVO BRAKES

Reverse braking - 15 - 20%. Axle rating - 5,200 lb. Wheel size - 14.5" - 16"  
Marine cluster has galvanized back plate, stainless steel spring hardware, plated wheel cylinder and riveted marine brake shoe.

PRODUCT	RIGHT#	LEFT#	BOLT HOLE PATTERN	WT (LBS.)
Marine	SB23510M	SB23511M	5 on 3.875"	19

PRODUCT	TYPE	DESCRIPTION
Shoe Kit	07813	2 Front - 2 Rear

## DRUMS FOR BRAKE ASSEMBLIES

### 10" BRAKE DRUMS

ITEM#	DICO ITEM#	# OF BOLTS	BOLT HOLE DIA.	BOLT CIRCLE DIA.	PILOT HOLE DIA.	STYLE	WT (LBS.)
11777	NA	5	1/2"	5 1/2"	4"	A	12



11777

### 12" BRAKE DRUMS

ITEM#	DICO ITEM#	# OF BOLTS	BOLT HOLE DIA.	BOLT CIRCLE DIA.	PILOT HOLE DIA.	STYLE	WT (LBS.)
13717	NA	6	5/8"	5 1/2"	4 3/8"	B	14



13717

# 13" HYDRAULIC BRAKE ASSEMBLIES

## BRAKE CLUSTERS

**Free Backing Brakes (shown)**  
Reverse braking - minimal.  
Wheel size - 16" - 22.5"

PRODUCT	RIGHT#	LEFT#	BOLT HOLE PATTERN	WT (LBS.)
Standard	01971	01970	4 on 4.813"	21

PRODUCT	TYPE	DESCRIPTION
Shoe Kit	5508	2 Front - 2 Rear



01971

## UNI-SERVO BRAKE CLUSTERS

**Uni-Servo Brakes (shown)**  
Reverse braking - 15 - 20%.  
Wheel size - 16" - 22.5"

PRODUCT	RIGHT#	LEFT#	BOLT HOLE PATTERN	WT (LBS.)
Standard	07911	07910	4 on 4.813"	21

PRODUCT	TYPE	DESCRIPTION
Shoe Kit	5509	2 Front - 2 Rear



07911

## BRAKE DRUMS

ITEM#	DICO ITEM#	# OF BOLTS	BOLT HOLE DIA.	BOLT CIRCLE DIA.	PILOT HOLE DIA.	STYLE	WT (LBS.)
05353	9894	8	5/8"	8"	5 3/4"	A	20.6
07324	16964	6	17/32"	8 1/4"	6"	A	20.3
03532	18859	8	17/32"	5 1/2"	4 3/8"	B	22.5
03940	10111	6	17/32"	5 1/2"	4 3/8"	B	22.6
03941	43268	8	17/32"	5 1/2"	4 1/2"	B	21.9



07324

03532

## BRAKE FLANGES

ITEM#	PLATE DIMENSIONS	PILOT HOLE	PILOT
54988	.25" X 4.25" X 4.25" - 4 ON 4.813"	21/2"	.91
60124	.25" X 4.25" X 4.25" - 4 ON 4.813"	23/4"	.91
52415	.25" X 4.25" X 4.25" - 4 ON 4.813"	3"	.84
61715	.25" X 4.25" X 4.25" - 4 ON 4.813"	31/4"	.76
59911	.25" X 4.25" X 4.25" - 4 ON 4.813"	31/2"	.65



54988

60124

52415

61715

59911



## SINGLE SOLID AXLE KIT

ITEM #	DESCRIPTION	WT (LBS.)
6097	180" Main Line With 72" and 30" Lines	2
5402	193" Main Line With 66" and 17" Lines	2
5426	193" Main Line With 80" and 17" Lines	2
5427	193" Main Line With 72" and 17" Lines	2.5
5643	240" Main Line With 66" and 17" Lines	2.5



## SINGLE TORSION AXLE KIT

ITEM #	DESCRIPTION	WT (LBS.)
5424	193" Main Line With 66" and 17" Lines	3



## TANDEM SOLID AXLE KIT

ITEM #	DESCRIPTION	WT (LBS.)
6098	180" Main Line With 72" and 30" Lines	4
5951	193" Main Line With 80" and 17" Lines	4
5403	193" Main Line With 66" and 17" Lines	4
5428	193" Main Line With 72" and 17" Lines	4
5429	193" Main Line With 80" and 17" Lines	4
6064	193" Main Line With 66" and 4.5" Lines	4



## TANDEM TORSION AXLE KIT

ITEM #	DESCRIPTION	WT (LBS.)
5425	193" Main Line With 66" and 17" Lines	4



## ACTUATOR BRAKE BLEEDER

ITEM #	DESCRIPTION	WT (LBS.)
10142	Master cylinder adapter for use with power bleeder (Rubber washer included)	1
09215	Rubber washer	



10142

## HARD LINES

### .188 Double Flared Aluminum Galfan

ITEM #	LENGTH	DESCRIPTION	ITEM #	LENGTH	DESCRIPTION
SB5045	4 1/2		SB553	53	
11968	6		SB560	60	
SB508	8		SB566	66	
SB512	12		SB572	72	
SB517	17		SB580	80	
SB520	20		SB590	90	
09098	24		SB597	97	
SB530	30		SB5120	120	
SB532	32		07913	128	Armored Galfan Metal
SB536	36		SB5180	180	
SB537	37		SB5193	193	
SB540	40		SB5230	230	
SB541	41		SB5240	240	
SB550	50				

## FLEXIBLE BRAKE HOSES

### SAE 1401

ITEM #	LENGTH	DESCRIPTION	ITEM #	LENGTH	DESCRIPTION
SB7H66	7	Solid Female (2x)	09571	24	Solid Male & Female
SB7H67	7	Swivel Male & Solid Female	11876	25	Solid Female Swivel Male with 90° Line
10433	9	Solid Female (2x)			
02032	12	Solid Male & Solid Female	11714	27	Solid Male Solid Female
SB12H137	12	Solid Male & Solid Male	13858	28	Swivel Male with 90° & Solid Female
SB13H66	13	Solid Female	11738	36	Double Swivel Male With Coiled Armor Spring
13958	17	90° Swivel Male Ends (2x)			
SB18H137	18	Solid Male & Swivel Male	15009	36	Swivel Male & Solid Female
11627	18	Swivel Male with 90° & Solid Female	02034	45	Solid Female (2x)
05982	19	Solid Male & Solid Female	05979	52	Swivel Male & Swivel Male
13788	20	1/2 Solid Male & Solid Female	14006	62 45°	Elbow Male & Solid Male
SB24H137	24	Solid Male & Swivel Male			

## BRAKE ACCESSORIES

ITEM #	DESCRIPTION
02549	Brake line protector rubber x .75" long
SB7764	Brake line clip
05981-95	Bracket pltd for brake line hose
01863	5/8 Rubber grommet

## FITTINGS

ITEM #	DESCRIPTION
10375	Ftg .125 MPT X .125 MPT nipple
10737	Ftg Elb .125 MPT X .125 FPT 90° street elbow
10376	Ftg Elb .125 MPT X .20 HB brass
10373	Ftg Str .20 Hb X 10-32 NF Tapered brass
SB7785	Ftg Tee .188 inverted flare with bracket
SB7900	Ftg Tee .188" adapter female (2) male (1)
SBD10	Ftg union .188" female
11436	Ftg .125 MPT X .125 FPT elbow
05679	Ftg .125" MPT X .188" inverted flare

# SPARE TIRE MOUNTS

## 15850 STAKE POCKET MOUNT

ITEM #	FINISH	DESCRIPTION
15850-52	Silver	Stake Pocket Spare Tire Holder - Fits 2x4 standard stake pocket up to 3" deep . Accepts bolt patterns from 2.5" - 6.5"
15850-76	Black	Stake Pocket Spare Tire Holder - Fits 2x4 standard stake pocket up to 3" deep . Accepts bolt patterns from 2.5" - 6.5"
15884-52	Silver	Stake Pocket Spare Tire Holder with 4" offset - Fits standard stake pocket up to 3" deep. Accepts bolt patterns from 2.5" - 6.5"
15884-52	Black	Stake Pocket Spare Tire Holder with 4" offset - Fits standard stake pocket up to 3" deep. Accepts bolt patterns from 2.5" - 6.5"



## 15851 TONGUE MOUNT

ITEM #	FINISH	DESCRIPTION
15851-52	Silver	Vertical Spare Tire Holder - Fits trailer tongues up to 4"x4" . Accepts bolt patterns from 2.5"-6.5"
15851-76	Black	Vertical Spare Tire Holder - Fits trailer tongues up to 4"x4" . Accepts bolt patterns from 2.5"-6.5"



## 15853 JACK MOUNT

ITEM #	FINISH	DESCRIPTION
15853-52	Silver	Universal Jack Mount Spare Tire Holder - will mount opposite of bolt on swivel jacks. Accepts bolt patterns from 2.5"-6.5"
15853-76	Black	Universal Jack Mount Spare Tire Holder - will mount opposite of bolt on swivel jacks. Accepts bolt patterns from 2.5"-6.5"



*Tire mounts are available in 2 FINISH options:*



Silver: -52

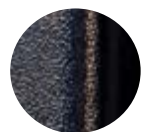

Black Texture: -76

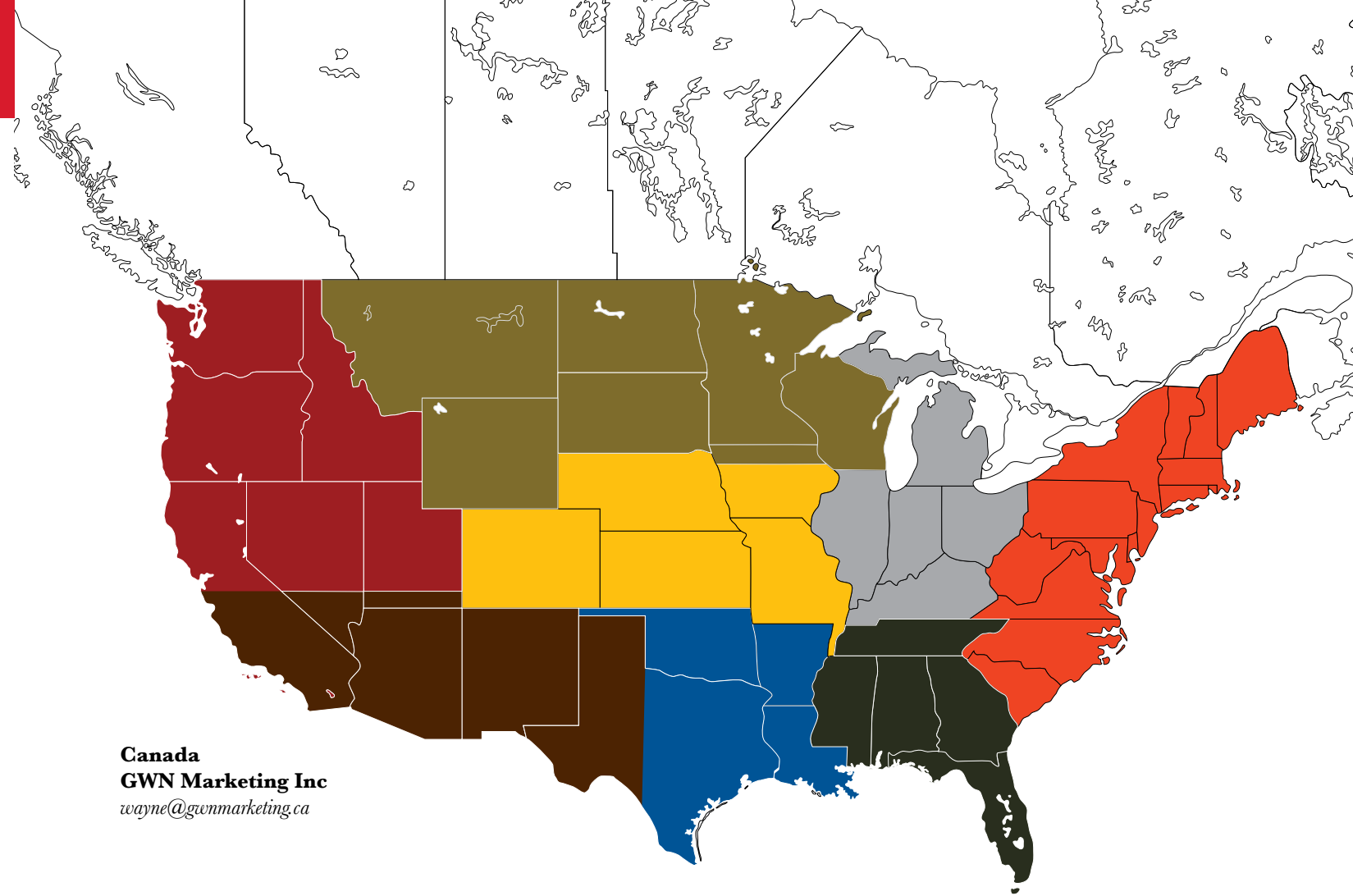

Canada  
GWN Marketing Inc  
wayne@gwnmarketing.ca

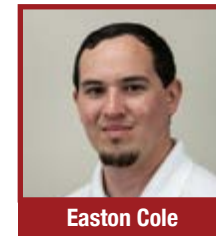

Easton Cole

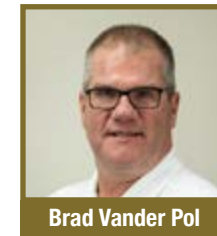

Brad Vander Pol

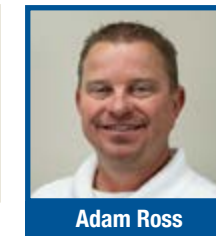

Adam Ross



Chris Cherryholmes



Greg Emerson



Jeff Johnson



Mike Strasser



Craig Snider

- **Easton Cole** || Trailer Products & RV Products/Territory Manager || [easton.cole@demco-products.com](mailto:easton.cole@demco-products.com)
- **Brad Vander Pol** || Trailer Products & RV Products/Territory Manager || [brad.vanderpol@demco-products.com](mailto:brad.vanderpol@demco-products.com)
- **Adam Ross** || Trailer Products & RV Products/Territory Manager || [adam.ross@demco-products.com](mailto:adam.ross@demco-products.com)
- **Chris Cherryholmes:** || Trailer Products & RV Products/Territory Manager || [chris.cherryholmes@demco-products.com](mailto:chris.cherryholmes@demco-products.com)
- **Greg Emerson** || Trailer Products & RV Products/Territory Manager || [greg.emerson@demco-products.com](mailto:greg.emerson@demco-products.com)
- **Jeff Johnson** || Trailer Products & RV Products/Territory Manager || [jeff.johnson@demco-products.com](mailto:jeff.johnson@demco-products.com)
- **Mike Strasser** || Trailer Products & RV Products/Territory Manager || [mike.strasser@demco-products.com](mailto:mike.strasser@demco-products.com)
- **Craig Snider** || Trailer Products & RV Products/Territory Manager || [craig.snider@demco-products.com](mailto:craig.snider@demco-products.com)

# DEMCO

## Boyden

4010 320th Street  
Boyden, IA 51234  
Ph. 800.543.3626

## Spencer

1300 38th Ave W.  
Spencer, IA 51301  
Ph. 800.543.3626

**[www.demco-products.com](http://www.demco-products.com) • 800-543-3626**

[www.demco-products.com](http://www.demco-products.com)

